



THE FIGHTER COLLECTION



Eagle Dynamics

**DCS**

**L-39**  
**ALBATROS**



**DCS: L-39 Albatros**  
**Flight Manual**

## Table of contents:

HISTORY .....	8
L-39 Development .....	8
L-39 Further Development and Modernization .....	19
L-39ZO X-09 .....	19
L-39ZA X-11 .....	20
L-39C Flying School Desk .....	22
L-39 In Local Conflicts.....	25
Modern Time.....	26
Aerobatic Teams Flying L-39C .....	28
Modifications .....	33
AIRCRAFT OVERVIEW .....	38
General Description of the L-39C .....	38
Design .....	40
Airframe.....	42
Cockpit .....	45
VS1-BRI Ejection Seat.....	49
Hydraulic System .....	49
Utility Hydraulic System .....	50
Aircraft Controls .....	61
Trimmer Controls in the Front and Rear Cockpit.....	63
Environmental Control System.....	65
Air Conditioning System.....	66
Fuel System .....	70
Fuel Use Order.....	71
Indicators .....	72
Engine Fire Extinguishing Equipment .....	73
Fire Detection and Indication System .....	74
Fire Extinguishing System.....	75
Anti-Icing System .....	77
Anti-Icing System Control and Indication .....	78

AI-25TL ENGINE .....	79
GENERAL SPECIFICATIONS, OPERATION PRINCIPLE AND MAIN ENGINE DATA .....	79
Engine Main Specification and Restrictions .....	91
Aviation Equipment .....	92
Electrical Equipment .....	92
Lighting System.....	102
COCKPIT L-39C .....	113
Front Cockpit .....	113
Central Panel .....	114
Left Panel .....	116
Right Panel .....	118
Rear Cockpit.....	120
Central Panel .....	121
Left Panel .....	123
Right Panel .....	125
Instruments.....	127
Flight and Navigation Instruments .....	127
FLIGHT .....	163
L-39C Structural Limits .....	163
Engine Start Preparation.....	165
Cold start.....	165
Perform Engine Start.....	167
After Engine Start .....	172
Preparing For Taxiing And Taxiing.....	174
Circle Pattern Flight.....	175
Takeoff .....	175
Crosswind Takeoff And Landing .....	183
Engine Shutoff .....	183
Circle Pattern Flight.....	184
Aerobatics .....	185
General Information .....	185

Behavior of the Airplane at Minimum Speeds .....	186
Spin .....	186
Use of RSBN-5S ("ISKRA-K") Equipment for Flight and Navigation .....	188
NAVIG (NAVIGATION) MODE.....	188
Initial Approach and Landing Using RSBN-5S (Iskra-K) Equipment .....	190
Approaching Airfield Using RKL-41 .....	194
COMBAT EMPLOYMENT .....	197
Aircraft Armament .....	197
Bomb Armament.....	197
Unguided Weapon.....	198
Guided Missile Weapon.....	199
Armament Controls and Signalization in Front Cockpit.....	201
Armament Controls and Signalization in Rear Cockpit.....	202
Aiming and Photo Equipment .....	203
ESKR-46 Signal Flares.....	207
Ground Target Engagement Pre-flight Preparation.....	209
Fictitious target base calculation .....	209
Bombs Delivery .....	209
Unguided Rockets Delivery .....	213
Combat Employment at Aerial Targets .....	217
L-39ZA .....	221
Introduction .....	221
General description of the aircraft.....	221
Operating Limitations.....	224
Cockpit Equipment.....	225
Front cockpit.....	225
Rear Cockpit.....	231
Aircraft and Engine Systems.....	232
Fuel system .....	232
PT-12 engine overheat control system.....	235
Aircraft equipment .....	235

Armament and Combat Employment .....	237
Aircraft Armament .....	237
Bombing Armament.....	237
Rocket Armament.....	241
Missile armament .....	242
GS-23L Gun .....	244
PK-3 Machine-Gun Pod .....	246
Control and Indication Elements in the Front Cockpit .....	249
Armament panel.....	249
Center Panel .....	250
R-3S, R-60 and GS-23 Control Panel.....	251
Annunciator Panels.....	252
Bombs Delivery.....	253
Rockets Firing.....	256
Air-to-Air Missiles .....	259
Firing the GS-23 Gun on Ground Targets.....	262
Firing the PK-3 Machine-Gun pods on Ground Targets.....	265
<b>EMERGENCY PROCEDURES .....</b>	<b>270</b>
Engine Failure.....	270
Air Start of the Engine .....	270
Spontaneous Changing or Holdup of Engine RPM .....	271
Engine Fire .....	273
Engine Surge .....	273
Landing Gear Failure (Emergency Gear Extension) .....	274
ADI Failure .....	274
GMK-1AE Failure.....	275
Flaps Non-Extension.....	275
Oil Pressure Drop at Engine.....	275
Pitot System Failure .....	276
Bingo Fuel .....	277
Main Generator Failure.....	277

Primary and Backup Generators Failure.....	278
Canopy Destruction .....	278
Smoke in Cockpit – Cockpit Depressurization .....	278
Forced landing.....	279
Flameout Landing .....	280
Flameout Belly Landing .....	281
FLIGHT CHARACTERISTICS .....	283
Typical Speeds of Level Flight.....	284
Service Ceiling .....	285
Airplane Controllability .....	285
Pitch Balance in Level Flight .....	285
SUPPLEMENTS .....	288
Airdrome Data of Caucasus Map .....	288
Airdrome Data of NTTR Map.....	289
Sources.....	290
Eagle Dynamics .....	291
Management.....	291
Programmers.....	291
Artists .....	292
Sound .....	292
Quality Assurance .....	292
Science Support.....	293
IT and Customer Support .....	293
Localization.....	293
Testers Staff.....	293
Special Thanks.....	295

# HISTORY



# HISTORY

## L-39 Development

Development and production of aircraft have always been one of the high priority tasks in those countries leading on the world stage. However, also several small countries developed airplanes, which took an honorable place in aviation history. One of those countries is Czechoslovakia. On January 1<sup>st</sup>, 1993, the country peacefully divided itself into the Czech Republic and Slovakia. One of the directions in the airplane industry was jet trainers. The L-39C "Albatros" became one of the most mass-produced jet trainers, taking 4<sup>th</sup> place in the world after the American T-33, the Soviet MiG-15UTI and its compatriot, the L-29 "Delfin" (English: dolphin).



Figure 1: L-29 "Delfin"



Developed in 1956, the L-29 "Delfin" won the Warsaw pact countries' jet trainer competition. It marked a new era in pilot training, was very easy to pilot, robust and undemanding in service. At the same time, this airplane had several disadvantages and enhancement attempts showed that the L-29 had limited potential for modernization. Besides that, the fast evolution of aviation posed new requirements in young pilots' training. Thus, there was a need for a new jet trainer.

The Ministry of National Defense (MND) of Czechoslovakia officially ordered the airplane. MND started developing technical specifications in 1963. Work was ongoing in collaboration with the main customer – the Ministry of Defense of the Soviet Union. In particular, it was required to keep the positive qualities of the L-29, increase thrust-to-weight ratio and reliability in operations from unpaved runways. It was indicated that the maximum speed should not exceed 700 km/h. Special attention was paid to the trainee and trainer cockpits. They should be similar to the cockpits of combat airplanes.

This task was delivered to the team, headed by the main constructor Jan Vlček from the Aeronautical Research Institute in Letňany (LVÚ, now the Aeronautical Research and Test Institute, a.s. – VZLÚ). Karel Dlouhý was the project's chief designer.

On July 15<sup>th</sup>, 1964, final specifications of the new jet trainer were ready and the name for the new airplane L-39C "Albatros" was approved. After 1,5 years of work, all design activities were transferred to Aero Vodochody, where Jan Vlček moved with his team.

From the beginning, Jan Vlček decided on the classical cantilever low-wing scheme, three-point retractable gear and with trainer behind the trainee tandem cockpit. For the L-39C a trapezoidal wing was chosen. It was decided to equip the L-39C with a ruggedized landing gear, which is quite common for all jet trainers. To protect the engine from foreign objects, air intakes were located on both sides of the fuselage over the wing. To teach trainees how to employ weapons, two hardpoints could be installed. The ground maintenance of the airplane was well thought out; in particular, size and location of various inspection covers were chosen thoroughly to ease ground maintenance as much as possible.

A lot of attention was paid to the selection of the power plant. From a reliability point of view, two engines were necessary, but this led to increased weight and fuel consumption. These disadvantages convinced the chief designer that one engine is enough, especially after taking into account increased jet engine reliability. Regarding engines, the plan was to install the Czech M-270 with thrust up to 2500 kgF, which Prague "Motorlet" factory was working on. The Soviet side was insisting on installation of the AI-25 with 1450 kgF thrust, which was in the final stage of development at the "Progress" design bureau (located in Zaporozhje), headed by A.G. Ivchenko. In the end, the AI-25 was chosen, because Prague's engine was slightly too big for the light jet trainer. Besides that, after stand testing, it was obvious that operational development of this engine could not be finished fast enough.

During 1964-66, models in scale 1:4, 1:5 and 1:25 were verified in the LVÚ's wind tunnels. Based on these results, the form of the wing, the air intake configuration and several other components were finalized. In February 1967, a wooden model of the airplane was ready and a prototyping committee started working.

In the same year, a model manufactured in Letňany was tested in "TsAGIs" (Central Aerohydrodynamic Institute) high-velocity and spin wind tunnels nearby Moscow. Similar testing continued in Czechoslovakia. By the end of 1968, all aerodynamic testing was finished.



**Figure 2: L-39 model, 1:1 scale**

In the meantime, the “Motorlet” plant was preparing a licensed production of the Soviet engine, which received the local name AI-21W (W – “Walter”). In the beginning it was decided to produce only a small number of these engines. Several units from this lot were tested on stand in Prague and on the Il-28 flying lab at LVÚ. Due to the fact that the AI-25 initially could not produce sufficient thrust, Czech engineers started its modernization. Soon a decision was made, that all mass-produced airplanes would have the improved AI-25TL engine with 1720 kgF of thrust, delivered by the Zaporozhye Engine Plant (today the joint-stock company “Motor Sich”).

The VS-1 ejection seat, developed at LVÚ by Jiří Matějček, was planned to be installed on the airplane. Apart from the ejection mechanism, the seat had to be equipped with a rocket booster, allowing ejection from the airplane on the ground. In 1967, designers manufactured several seat prototypes and started ground testing. The next year they manufactured several prototypes of VS-1B ejection seats. They had no rocket boosters, because development of this unit was delayed. At the same time, those seats were tested on the MiG-15UTI flying lab. Around 50 ejections were performed. They showed that pilots could safely leave the airplane from heights no less than 300 m, and it could be used on the first L-39C prototypes. Besides that, various L-39C systems were tested as well.

For testing it was decided to build seven L-39C prototypes at once. Five of them (X-02, X-03, X-05, X-06, X-07) were intended for flight testing, while X-01 and X-04 were used for static and fatigue testing respectively. Aero Vodochody was the main factory. Here, the nose and fuselage midsections were produced and the final assembly was done. The “Let” plant in Kunovice produced the wings, and Prague “Rudý Letov” was responsible for the tail part and empennage.



**Figure 3: X-02 prototype**

In the spring of 1968, the airframe for the X-02 prototype was ready. By mid-autumn, all necessary equipment and systems were mounted on the X-02. Due to a delay in the AI-25TL engine delivery, the AI-25W was installed. On October 25<sup>th</sup>, 1968, the airplane was rolled out for the first time. Ground testing started at the factory airfield, where special attention was given to engine operation, landing gear, control system and wing mechanization. The tests were performed by Aero Vodochody chief pilot Rudolf Duchoň. On October 28<sup>th</sup>, 1968, the airplane on three occasions accelerated up to 175 km/h with nose gear lifting. The pilot noted good airplane behavior, brake efficiency and a surprisingly good view from the cockpit.

After fixing several small issues, the L-39C was prepared for its first flight. The airplane had the civil registration OK-32 (later changed to OK-180) on the fuselage. On November 4<sup>th</sup>, 1968, Duchoň took off for the first time. The takeoff was performed without flaps. Flaps efficiency was evaluated at a height of 1000 m; the pilot estimated that with flaps extended, the airplane remained in the air at a speed of just 160 km/h. During the first flight, air brake functionality, landing gear extraction/retraction operation and engine behavior in various modes were tested. The airplane landed with flaps in takeoff position. The duration of the flight was 35 min.



**Figure 4: X-02 prototype landing after the first test flight**

Literally 10 minutes after landing, Duchoň had to take off again. High level authorities arrived on the factory's airfield and it was decided to arrange an air show with solo and group aerobatics for them. At first, accompanied by a single-seat L-29A, the X-02 flew at low altitude with extended air brakes and switched on landing lights. Later, high speed passes followed, which were finished by a spectacular climb and combat turn. The guests were quite impressed by this improvised air show.

After these flights, X-02 was returned to the workshop, where a small operational development of the control system was completed. On December 2<sup>nd</sup>, 1968, the airplane was shown to the customer representatives.



**Figure 5: After the first official X-02 prototype test flight. From left to right: Jan Vlček, Rudolf Duchoň, Karel Dlouhý.**

In general, the testing followed a planned program. High angle of attack (AoA) flights, complex aerobatic maneuvers and several experimental flights to test the efficiency of the anti-spin parachute were performed. It turned out that such parachutes had a very low efficiency. Takeoffs and landings on the unpaved LVÚ runway in Letňany were conducted. During one of the days, the good handling of the L-39C was proven, when the aircraft landed with crosswind gusts from 10 to 14 m/s. From time to time, the flights were interrupted for further operational development. For example, the cockpit air conditioning system started operating, and, by the spring of 1969, new wing root fairings were installed.

By that time, engine operation became a growing concern. During one of those flights, several short engine surges happened and on March 19<sup>th</sup>, 1969, during a dive after exiting a spin, the engine spontaneously went out. Duchoň, using all his skills, managed to successfully land the airplane. The turbine blades were damaged. Despite this incident, the chief pilot wrote in his report that the overall impression of the plane was very good. First of all, he noted easy landing, great airplane handling and mentioned that, when operation development was finished, flight performance would be outstanding.



**Figure 6: Preparation of prototype X-03 for the test flight**

On May 4<sup>th</sup>, 1969, Duchoň took off in the X-03 prototype, which was equipped with the AI-25W engine. This airplane differed from previous ones in several aspects: The airplane had a different size of the wing root fairings, additional “windows” on the side of the air intakes and adjustable rudder trimmer. X-

03 was then handed over to LVÚ to continue the test program. Another incident happened: During one of the flights, the rear cockpit canopy was torn off and barely missed the empennage.

The same X-03 prototype was used for experimental flights in icing conditions and to verify operation of the VS-1BRI ejection seat.



**Figure 7: VS-1BRI ejection seat testing**

On September 23<sup>rd</sup>, 1969, the X-05 prototype, piloted by Duchoň, took off. The airplane was equipped with the same engine as its predecessors, but had different shaped intakes and wing root fairings as well as two hardpoints. During the first eight flights, special attention was paid to engine operation. Later, in October, the airplane was tested at minimum speeds and the engineers faced another engine surge.



**Figure 8: X-05 prototype**

In April 1970, X-05 was used to test airplane behavior during aerobatic figures. In one of the flights over-G occurred, resulting in deformation of the upper wing skin. The wing was sent to the manufacturer for repairs, and the old engine, which operated for 50 hours, was replaced with a new one. In July 1970, flights started again. The engine was changed once again at the end of August. At the end of October, beginning of November, 16 spin test flights were conducted. Having performed 78 spin turns in total, the pilots came to the conclusion, that the airplane exited spins easily and without any delays. During this program, the engine was changed twice, because of severe problems. By the end of 1970, X-05 had performed 159 flights.

On April 28<sup>th</sup>, 1970, X-06 took to the air. The airplane had new air intakes and the auxiliary power unit (APU) "Saphir-5" (also "Safir-5" or "Sapphire-5"), produced by PBS Velká Bíteš under license from the French company "Turbomeca". On July 1<sup>st</sup>, 1970, while performing a landing approach, the left landing gear did not extend as expected. Vlastimil David tried to retract and extend the landing gear leg several times, but ultimately did not succeed and had to perform an emergency belly landing. The investigation following the incident revealed a factory defect as the reason.



**Figure 9: X-06 prototype after emergency belly landing**

On December 15<sup>th</sup>, 1970, the X-07 prototype took off. "The seventh" was initially built to incorporate the AI-25TL engine, but the AI-25W was installed at first. On this airplane the shape of the root wing fairing was changed once again and fairings between wingtips and wing fuel tanks were installed. Some solutions used on other prototypes were not used on X-07, for example an adjustable stabilizer. In July 1971 the control system was modified. To reduce the effort needed to deflect the elevator to more than 28°, a special spring mechanism was installed and to reduce efforts on the pedals, the rudder servo compensator was lengthened by a quarter. This improved airplane handling during takeoff.

At the end of summer – beginning of autumn 1971, X-05 and X-07 passed military tests, having a combined number of 115 flights together. The engineering staff worked 560 man-days during that time, which was equal to 39 man-hours per flight hour. Indeed, some say "Success in flight is forged on the ground!".

During these tests, it was mentioned that due to increased weight of “the seventh”, some characteristics, compared to other prototypes, somewhat deteriorated, but in general remained on acceptable level.

In the end of 1971, the long-awaited Al-25TL arrived from Zaporozhye. X-02 was the first prototype to receive this engine in the beginning of 1972. The airframe was strengthened and some other improvements were made. By the end of March 1972, the Al-25TL was installed on X-07 as well. Due to increased weight of the engine, the center of gravity of the machine was shifted. This led to changes in the layout of electrical equipment, in particular batteries were moved to the aircraft’s nose. After a short testing by factory pilots, the prototypes were transferred to military testing, which was completed in the beginning of 1973. Experimental flights showed that the thrust increase led to a significant improvement in flight performance. The new engine had better gas-dynamic stability as well. However, flight duration decreased slightly, but still remained at an acceptable level. On one full tank, the L-39 could perform fourteen 7-minute or eleven 9-minute flight circles or two 40-minute flights to the aerobatic area. Military pilots tested the X-07 on stall behavior. Their results differed very little from those obtained on the X-05 prototype. Before the stall warning, a shaking of the airplane with the stick jerking occurred, followed by a nose fall and a smooth slow roll.



**Figure 10: X-07 prototype**

Besides that, during 1972, the X-02 and X-07 were used for special testing. In particular, in the beginning of autumn, new air conditioning turbo-cooler operation was tested on “the second”. An extensive program for testing the electronic equipment was conducted on “the seventh”.

In the beginning of 1973, X-07 was prepared to be sent to the USSR for a government test program at GK NII VVS (Soviet Air Forces Flight Research Institute). By that time, the airplane completely corresponded to the production modification L-39C (Cvičná - trainer). It was repainted, got red stars, the plane number № 07 and additional test equipment. Government testing started in May 1973. The Soviet pilots formed a favorable opinion about the airplane. They noted that the L-39C met all requirements for a training aircraft. Among the positive qualities of the airplane, special attention was paid to: the similarities with cockpits of combat aircraft for both the trainee and the trainer, a great view from both places, a robust emergency system, the possibility to start the aircraft without ground-based



services, as well as basic combat training and MiG-21 landing approach simulation (with retracted flaps).

There were also several disadvantages mentioned, including the lower-than-defined operational range, higher landing speeds and longer landing roll out. Soviet and Czech pilots had significantly different opinions regarding spin behavior. Spin tests, performed according to GK NII VVS test procedure, showed that spins in the L-39C had “unstable and uneven” characteristics and that the airplane usually exited the spin after its 3<sup>rd</sup> rotation. Despite the shortcomings found in the L-39C, it was recommended to put the airplane in service of the USSR Air Force and issue it to flight schools.

After receiving the comments from the customer, the developer started to address them. Special attention was paid to the L-39C’s spin behavior. During 1974, work was performed on the X-02 and X-07 prototypes. Several different design solutions were worked out, including special ridges on the nose sides for “the second”. Though tests showed that this measure improved airplane behavior, it was decided to not use this solution. In the end, angle of attack restrictions were introduced and more sophisticated spin exit methods were worked out.

It was planned to start manufacturing the L-39C in 1971, but the implementation of this program faced several serious difficulties. First of all, the prototypes were still under testing and the final production configuration was not defined yet. In addition, initial delivery dates for the Al-25TL lagged behind schedule.

As a result, it was decided in 1971 to build an initial production lot, consisting of 10 L-39Cs, equipped with the Al-25W, which had to be received by MND.

On December 7<sup>th</sup>, 1971, the first airplane from this lot took off and on March 28<sup>th</sup>, 1972, five airplanes were transferred to the flight school in Košice.



**Figure 11: L-39V (Vlečná - tug) – single-seat KT-04 target tug**

As planned, after the end of the AI-25W engine's service life, the L-39Cs from the first lots were equipped with the AI-25TL. This was done in 1974. In the same year, L-39C went into mass production, which continued until 1999. In total, there were more than 2,950 airplanes built, without taking into account the first seven prototypes. The L-39C trainer became the most mass-produced modification, in the amount of 2,280 units. The USSR Air Forces received 2,080 airplanes (the latest one was received on January 25<sup>th</sup>, 1991).

In 1970, prototyping of the X-08 L-39V (Vlečná - tug) – single-seat KT-04 target tug started. This airplane was requested by MND. In July 1972, the X-08 prototype was built. In the rear cockpit a towing winch was installed, which had up to 1700 meters of 5-mm steel cable wound. It was driven by an L-03 ram air turbine, located under the fuselage. This modification of the airplane had no air brakes. The KT-04 target itself was created by the "Rudý Letov" factory under the guidance of Jan Franc. It was an all-metal airplane, weighing 110 kg, with a length of 4,9 m, a wingspan of 5,3 m and was intended for cannon fire practice by both pilots and ground based anti-air artillery crews. Before takeoff, the KT-04, installed on a trolley, was attached to the winch cable with a special grip. During takeoff, the distance between the tug and the target was 100 m. After reaching 230 km/h at a height of 5 m, the trolley separated from the KT-04. Operating heights of the target were between 500 – 2500 m. The standard towing speed was 500 km/h, the maximum speed was 600 km/h. The distance between the airplane and the target during shooting was about 1500 m. After the shooting exercise, the KT-04 separated itself from the cable, descended by parachute and landed on inflatable shock absorbers. After replacing the damaged parts, the target was again ready to use.

X-08 factory tests started in October 1972 and comprised of 45 flights, including 30 flights with the target. Later, "the eighth" was used to study behavior of the airplane at lower speeds and to test the anti-icing system, equipped with the RIO-3 icing radioisotope probe. From July to September 1973, military testing of X-08 and KT-04 was conducted. By that time, the towing winch was equipped with a hydraulic cable cutter. A small lot of eight L-39Vs was produced in 1976. All of them were put in service with the Czech Air Force, but later two of them were transferred to the "Air Forces of the National People's Army", the air force of the German Democratic Republic.

Several experimental airplanes were created on basis of the original L-39C. Czechoslovakia's Air Forces used one of them during testing as recon airplane. The plane flew with locally developed recon containers on hardpoints, equipped with 4 AFA-39 cameras. This work did not receive further development.

The airframe of another L-39C was subjected to strength tests, the results of which allowed increasing the estimated service life from 3000 to 4500 hours.

In the Soviet Union one L-39C was used in LII (Flight research institute) of M.M. Gromov in 1981-85 as a flying lab for end airfoils testing. Results of this work were used during Il-96 and Tu-204 development.

## L-39 Further Development and Modernization

### L-39ZO X-09

In 1973, by order of the Libyan Air Force, development of the combat trainer L-39ZO (Zahraniční Obchod – armed, export variant) had begun.



**Figure 12: Libyan Air Force L-39ZO**

It was planned to use this airplane both for pilot training and as a light attack airplane. The aircraft had 4 hardpoints, which could carry a range of weapon systems. Each inner hardpoint was intended for 500 kg payloads, each external hardpoint for 250 kg, but in total the airplane could not lift more than 1100 kg. The new L-39ZO received strengthened wings and landing gear. The X-09 test flight started on June 25<sup>th</sup>, 1975, by Juraj Šouc. First of all, attention was paid to the airplane's behavior when shooting rockets, the impact of rockets' exhausted gases on engine operation and to the landing gear when working under excessive loads. In general, test flights gave very good results, though due to increased takeoff weight of L-39ZO, flight performances slightly deteriorated. The most serious problems during the X-09 test flight appeared after release of the 150-liter and 350-liter drop tanks. It was found, that after separation they began rotating about the transverse axis due to the incoming air flow. The speed and direction of rotation depended on aerodynamic forces and moments. There were several very unpleasant situations, when the drop tanks stayed "glued" to the wings, refusing to fall, and once even remained hanging on the pylon until the landing and fell off only during taxiing. The problem was solved by equipping the drop tanks with small horizontal surfaces, which created a dive moment. The test flights finished in June 1976. In total, 347 planes of this modification were built.

## L-39ZA X-11

In 1974, MND ordered one more L-39 combat training modification, with the name "L-39ZA" (the meaning of this abbreviation is not mentioned in public sources).

In contrast to its predecessor, this airplane was equipped with a 23 mm twin-barrel GSh-2-23 cannon, which was installed in the nose part of the fuselage under the cockpit and covered by fairings. Because of this, it was necessary to modify the fuselage, move several antennas, cover nose gear doors with stainless steel to protect them from hot propellant gases and once again equip gear with broader pneumatics.



**Figure 13: X-11 L-39ZA at Paris Air Show (Salon international de l'aéronautique et de l'espace, Paris-Le Bourget), June 1977.**

On May 16<sup>th</sup>, 1977, test pilot Juraj Šouc took the X-11 to the air. In the same year, this aircraft was painted in white-gray camouflage with civilian registration OK-HXA and was sent to the Paris Air Show in Le-Bourget. It was shown without the cannon, with two 350-liter drop tanks on the inner pylons or with one drop tank and a PFK-5 reconnaissance container. The airplane was presented both on the ground and in the air, performing complex aerobatics. The X-11 passed military tests in Košice flight school. L-39ZA mass production started in 1980.



**Figure 14: Czech Air Force L-39ZA**

The company Aero Vodochody achieved a very modest success in sales of new L-39C modifications. Mainly this can be explained by a huge number of L-39s, which are still in service and have great modernization potential. Moreover, many owners are satisfied with increased airframe service life after traditional maintenance with minimum financial costs. As a result, several programs were introduced in many countries, which could extend the L-39C life cycle by many years.

In the aircraft's home country, the MND and Aero Vodochody in June 1999 signed an agreement on a major overhaul and modernization of eight L-39s from the latest lots for the Czech Air Force. Following this agreement, the nose and tail parts of the airframe, the wings and some other parts of the equipment and systems were replaced. The airframe's service life was extended to 4500 hours. Similar work was conducted by Aero Vodochody on eight Hungarian airplanes, which were transferred to the customer on August 25<sup>th</sup>, 2005.

Slovakian L-39s were modernized by the airplane repair plant in Trenčín. In 1996-97, the first stage of service life extension was performed on six L-39s from the 1<sup>st</sup> and 4<sup>th</sup> lots, produced during 1973 – 1975. The airplanes got new noses from unfinished machines. In 1999-2000, similar procedures were conducted on two L-39Vs. In the same year, all L-39s came to Trenčín for the second stage of modernization. This time, tails and wings were replaced. After that, the airplanes got new avionics and various other airplane equipment. Among them were TACAN AN/ARN-153(V) radio navigation system, Pro Line II ADF-462 radio compass and GPS receiver – all manufactured by Rockwell Collins. The upgraded airplanes were named L-39CM. The head airplane (marked 0111) flew on August 26<sup>th</sup>, 2003, piloted by J. Kello and R. Rosenberg.

Russia developed a proprietary multi-stage program for modernization of the L-39C. It was planned to strengthen the airframe and extend its service life to 10.000 hours and to install four hardpoints, which would increase combat load from 250 to 900 kg. The plane had to be equipped with a K-93 ejection seat, new radio communication equipment and avionics, including the NK-39 navigation system, SVR-39 video recording system and SOI-39 display. Spare parts had to be manufactured in Russian

factories. The new airplane got the name "L-39MT", but this project was to remain on paper, because the Russian Air Force developed a program to replace the L-39C with the new Yak-130.

## L-39C Flying School Desk

L-39 geography is very broad. It was mainly used for its intended purpose. Usually, Soviet and Czech pilots were in the instructor role. For example, 10 specialists from Czechoslovakia (pilots and engineers) worked in Libya from April 1978 to June 1981. The intensity of their work can be judged based on the total amount of flight hours of pilot-instructor Štefan Župko. During this time, he performed 1302 flights with a total duration of 511 h 25 min. The L-39, which operated in the harsh conditions of North Africa (high temperatures, sandstorms, etc.) showed unpretentiousness and survivability. Only one serious accident occurred during the mentioned period. On July 5<sup>th</sup>, 1979, an airplane with a Czech instructor and a Libyan cadet did not return from a training flight. The airplane was found the next day in a water-filled ground hole on the sea shore. According to witnesses, the airplane suddenly entered into a dive, from which it did not exit. Reasons for the accident and the question, why no one from the crew attempted to eject, were to remain unclear.



**Figure 15: L-39C in the Russian Air Force**

Soviet instructors participated in cadet training in Afghanistan. The first 12 L-39Cs appeared in Afghanistan on October 2<sup>nd</sup>, 1977. From September 23<sup>rd</sup> to October 2<sup>nd</sup> 1977, Czech pilots flew the route with a total length of 5042 km from Vodochody to Mazar-i-Sharif through Košice, Lviv (Sknilov), Kiev (Juliani), Donetsk, Krasnodar, Makhachkala, Krasnovodsk, Ashkhabad, Chardjou and Tashkent. Technical experts accompanied the team on an An-24. The flight went flawless, without a single incident

and took 12 hours and 15 minutes of flight time. According to available information, it was the most distant L-39C group flight.

The flight-technical school in Mazar-i-Sharif was created in 1957, but by the time of the L-39Cs arrival, only 22 cadet pilots studied there. They had to learn how to fly in the 393rd UAP (Aviation Training Regiment). One year later, the revolution government of Afghanistan transformed the school into the Air Force and Air Defense College. The lack of local trainers was compensated by a large number of Soviet specialists. Major V.A. Pehotin became the advisor of the 393rd UAP commander. It must be said that the training program for the Afghan pilots was significantly different from the one existing at that time in the Soviet Union. After three years of study, young pilots were graduated on the L-39C. Later, they were retrained on the MiG-17, which was considered as a transitional machine before the MiG-21. For that purpose, pilots were sent to the Soviet Union. Soviet officers proposed to learn the MiG-21 immediately after the L-39C, according to the methodology accepted in the Soviet Union. Afghans did not agree. Former military advisor to the deputy chief of the school, V.I. Ablazov, wrote that the DRA Air Force commander Mir Gausuddin, looking at a passing caravan of nomads, remembered this proposal and said: "Your children are being born listening to TV noise, unable to speak, they already know how to turn on the lights and tape recorder, twitch a car wheel. When they grow up, they do not have problems to release one control knob and take hold of another. Our children break away from the donkey or camel tail, from the mother hem and you want to put them right into the modern airplane cockpit? Take your time and do not rush". It was hard not to agree with these arguments.



**Figure 16: L-39C in formation**

In the Soviet Union, the L-39C became one of the most popular military training airplanes. The machine quickly took root, "russified". The Latin "L" in its type designation was immediately replaced by the

Cyrillic "Л". The letter "C", indicating the training intention, disappeared completely, because in the USSR only the training modification was used. Pilots used the proper name "Albatros" less often than its slang nickname "Elka". The airplane arrived at the majority of flight schools: in Chernigov, Kachin and Kharkov, which specialized in preparing pilots for frontline fighter airplanes; in Armavir (air defense fighters); in Yeiskoe and Borisoglebsk (fighter-bombers); in Barnaul (frontline bombers); in Tambov (long-range aviation), in Krasnodar (prepared pilots for the Asian and African countries). The number of planes in training regiments was significantly higher than in combat ones. Some of them had over a hundred L-39Cs. L-39Cs were also in service at several combat training and pilot re-training centers and in the special training, flight testing regiment of the Cosmonaut Training Center of the USSR (airfield Chkalovskaya) and in GK NII VVS units. They were also used in several Su-25 regiments, where L-39Cs served as "twin-seaters", before the arrival of the Su-25UB trainers. In this role, several Soviet L-39Cs were used during the war in Afghanistan. Small numbers of L-39Cs were transferred to flying clubs and DOSAAF training centers. Also Flight Research Institute MAP (situated near Moscow Zhukovsky) had some L-39Cs. Their L-39Cs were used as flying laboratories, escort airplanes (for example during VKS Buran-analog flights) and in the test pilot school.

In the Soviet Union, a pioneering role in L-39C adoption was given to the 105<sup>th</sup> UAP of Chernigov Higher Military Aviation School (ChVVAUL), headed by Colonel D.I. Boryakov and located on Konops' airfield.

On October 20<sup>th</sup>, 1973, a group consisting of 8 officers, headed by the regimental deputy commander, Major S.N. Shamsutdinov, left for Czechoslovakia to study the new machines. Czech pilots flew the airplanes to Ivano-Frankovsk and from there these machines flew to the 105<sup>th</sup> UAP base under regiment pilots' control. The first L-39 was met in Konotop on April 29<sup>th</sup>, 1974.

Among the first flight instructors, which were retrained on the L-39C, were P.A. Leontiev, N.S. Saponchik, A.P. Holupov, I.P. Fedorenko, and A.T. Filichkin.

Among the first engineers were: V.I. Basco, V.P. Gardens, N.K. Panyuta, and A.I. Yakovina. Retraining was completed by the end of the year without accidents.

The airplane surpassed its predecessor L-29 in all respects and quickly won sympathies of the flight and ground personnel. The new "Elka" offered an excellent view from the cockpit, comfortable seats, an excellent air conditioning system, nice liveries and comfortable ergonomics.



## L-39 In Local Conflicts

The war in Afghanistan brought changes in the life of the 393rd UAP. Occasionally, L-39Cs, piloted by Afghan and Soviet trainers, were involved in combat missions. For example, from August 24<sup>th</sup> to 30<sup>th</sup>, 1979, they flew 11 combat missions to attack ground targets using rockets and bombs. Quite often, training flights were combined with Mazar-i-Sharif neighborhood reconnaissance. The first graduation of the pilots flying L-39Cs was held in August 1979. 15 pilots were graduated. The average flight time of every pilot was about 77 hours (22 hours without trainer) with 308 landings.



**Figure 17: Afghan Air Force L-39C**

Ethiopia had two L-39C wings, including the 16<sup>th</sup> training squadron, which was regularly involved in combat missions. At first they fought in Eritrea and after that took part in the civil war in Ethiopia. When in May 1991 rebels, fighting against the Mengistu Haile Mariam regime, approached Addis Ababa, L-39C pilots defended the capital until it was defeated. After that, about 50 airplanes and helicopters flew into neighboring Djibouti. Among them was one L-39C. In 1993, Eritrea became an independent state and Ethiopia's new authorities helped its former allies in the fight against the dictator regime, by training their pilots on the L-39C. But soon, in 1998, war between neighbors over territorial disputes began. L-39Cs were not observed in these battles. However, during training flights, L-39s regularly were under own air defense fire, because ground observers confused them with Italian MB-339s, which were in use by Eritrea's Air Force. One such incident occurred on the 13<sup>th</sup> of November 1998 near Mekele airfield: An L-39C with Ethiopia's captain Endegenä Tadesse and a Russian trainer, whose name was not mentioned in the press release, was shot down.

## Modern Time

The L-39 remains in service in more than 30 countries across the world, including the Russian Air Force. In Krasnodar's Military Aviation School, it is used as the primary jet trainer for basic flight training. Currently, the L-39C is being gradually replaced by the Yak-130.



**Figure 18: L-39C in the Russian Air Force**

A new phenomenon in the airplane's history was the private ownership of L-39Cs. In the Czech Republic the first private L-39 took off on August 13<sup>th</sup>, 2004. The airplane was bought in Ukraine and was previously operated by Chernigov flight school. Hardpoints and various military systems were removed and equipment necessary to meet international airways requirements was installed. The airplane was painted black and received the civilian registration OK-JET on the fuselage.



Figure 19: Private Czech L-39

## Aerobatic Teams Flying L-39C

**"Russ"** is an aerobatic team, created at Viazemsky DOSAAF aviation training center (ДОСААФ) in 1987. The aerobatic team flies L-39C jet trainers.



Figure 20: Russian aerobatic team "Russ"

**"Belaya Rus"** is an aerobatic team of the Air Force and Air Defense Forces of the Republic of Belarus that is performing aerobatics with the combat training aircraft L-39C "Albatros".



**Figure 21: Belorussian aerobatic team "Belaya Rus"**

**"Baltic Bees"** is an aerobatic team from Latvia, based in Tucums city. Baltic Bees pilots fly L-39C jet trainers.



Figure 22: Latvian aerobatic team "Baltic Bees"

"Patriots Jet team" is a private aerobatic team sponsored by Fry's Electronics. The team was organized by former United Airlines pilot Randy Howell.



Figure 23: Patriots Jet Team

"Breitling" is a private aerobatic team sponsored by the company Breitling, famous for its watches with the same name.



**Figure 24: Breitling Aerobatic Team**

The Breitling team is the largest civilian aerobatic team in Europe. The team is based on the military base in Dijon, France, and flies seven L-39C jet trainers.

**“Black Diamond Jet Team”** is a private aerobatic team with five L-39C and one T-33, all planes are painted in distinctive arctic camouflage. They are piloted by former military fighter pilots from the US Navy and Air Force.



Figure 25: Black Diamond Jet Team



## Modifications

L-39C is a standard modification of the jet trainer for basic and primary flight training. Usually, for standard modifications, the letter "C" in the name is omitted.



**Figure 26: L-39C**

L-39ZO is a modification of the airplane, which can be used as light attack airplane. For this purpose, it has 4 hardpoints.



**Figure 27: L-39ZO**

L-39ZA is a further L-39ZO evolution with 23 mm twin-barrel automatic cannon installed.



**Figure 28: L-39ZA**

L-39V is a single-seat target tug version.



**Figure 29: L-39V**

L-39D is a modification with installed BUR "Test-1" instead of SARPP-12. Additionally, BUR "Test-1" performs audio information recording for 5 hours and is equipped with operational storage.

L-39MS (L-59 Super Albatros) is a modification with the new modular DV-2 jet engine with 2200 kgF of thrust, "0-0" type ejection seats and new electronic equipment. It made its first flight in 1986. 80 airplanes were produced.



**Figure 30: L-39MS**

The L-39M1 is a Ukrainian L-39 modernization. The AI-25TL engine is replaced with the improved AI-25TLSH (thrust increased from 1720 to 1850 kgF and engine response time reduced from 8-12 seconds to 5-6 seconds). It has an improved engine control system. Also a new onboard emergency and operational flight information recorder with additional sensors and devices was installed.



**Figure 31: L-39M1**

The Aero L-159 "ALCA" is a Czech jet trainer (light attack plane). The airplane is based on the L-59 and is a further evolution of the L-39 "Albatros".



**Figure 32: L-159 ALCA**

The L-39 is in service in more than 30 countries. Many years of service proved that a very successful airplane was created. Thousands of pilots love the L-39, because, thanks to this airplane, they mastered basic flying skills and became pilots. It is rightly called "school desk". The airplane has modernization potential. L-39 systems and engine are being constantly improved and this allows this airplane to stay in service in many countries for a long time.

The history of the L-39 continues!

# AIRCRAFT OVERVIEW



# AIRCRAFT OVERVIEW

## General Description of the L-39C

The tandem seat combat trainer L-39C with the AI-25TL turbofan engine is designed for mastering pilot skills, air navigation in simple and adverse meteorological conditions during day and night, combat employment training, aiming and missile firing simulation at visually observed aerial targets, photo shooting at aerial targets, dive bombing (photo bombing) with 50-100 kg bombs, and the firing of S-5 rockets (photo shooting) at ground targets.

In the L-39C module, firing the R-3S heat seeker missile at aerial targets under clear visual conditions is implemented.

Dimensions of the L-39C:

- Length: 12.13 m
- Wingspan: 9.12 m
- Height: 4.47 m
- Main wheel track: 2.44 m

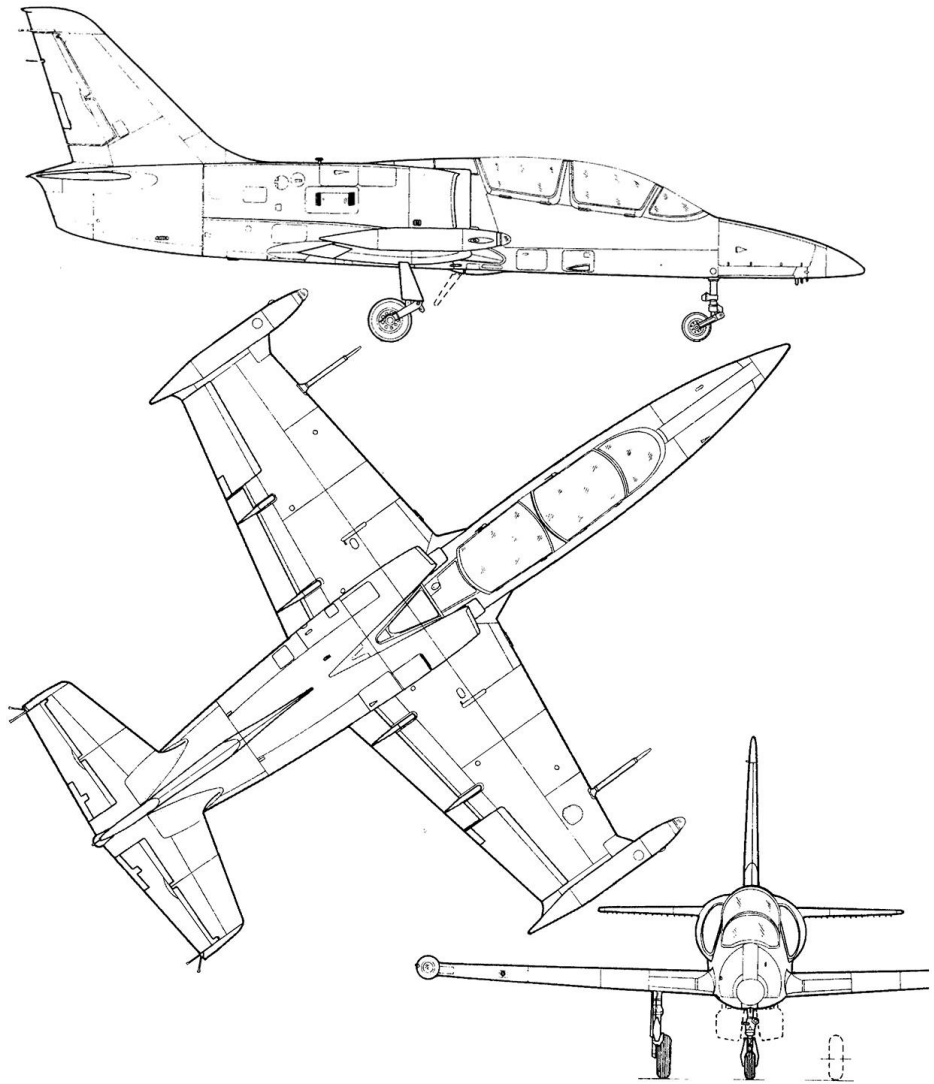

Figure 33: L-39 drawings

## Design

The L-39C is a conventional low wing cantilever airplane with trapezoidal wings. The empennage consists of a trapezoidal vertical stabilizer with rudder and horizontal stabilizers with elevators. The airplane has a three-wheel landing gear configuration including nose gear. The main gear struts are retracted into the wings and the nose gear into the fuselage.

The AI-25TL turboprop engine, developed under supervision of V.A Lotarev at the experimental design bureau, produces a maximum thrust of 1720 kgF and is mounted in the middle section of the fuselage.

The fuel for the engine is located in seven tanks: five fuselage fuel tanks, located behind the rear cockpit, and two permanent wingtip tanks.

There are two pressurized cockpits in the nose part of the fuselage. The cockpits are equipped with an environmental control system, which provides air conditioning and comfortable conditions at higher altitudes. It also allows the pilots to withstand allowed operational G-forces if special equipment is used.

The VS1-BRI ejection seats, installed in both cockpits, allow the pilots to leave the airplane in case of an emergency.

The canopy is sealed; its moving parts can be jettisoned by pyrotechnical systems in an emergency situation.

The wing is attached to the bottom of the fuselage. Ailerons and extendable double-slotted flaps are installed on the wing.

Various airplane equipment and avionics provide the possibility to fly during day and night in simple and adverse weather conditions.

The airplane can carry missiles, rockets and bombs and is equipped with aiming and photo control equipment.



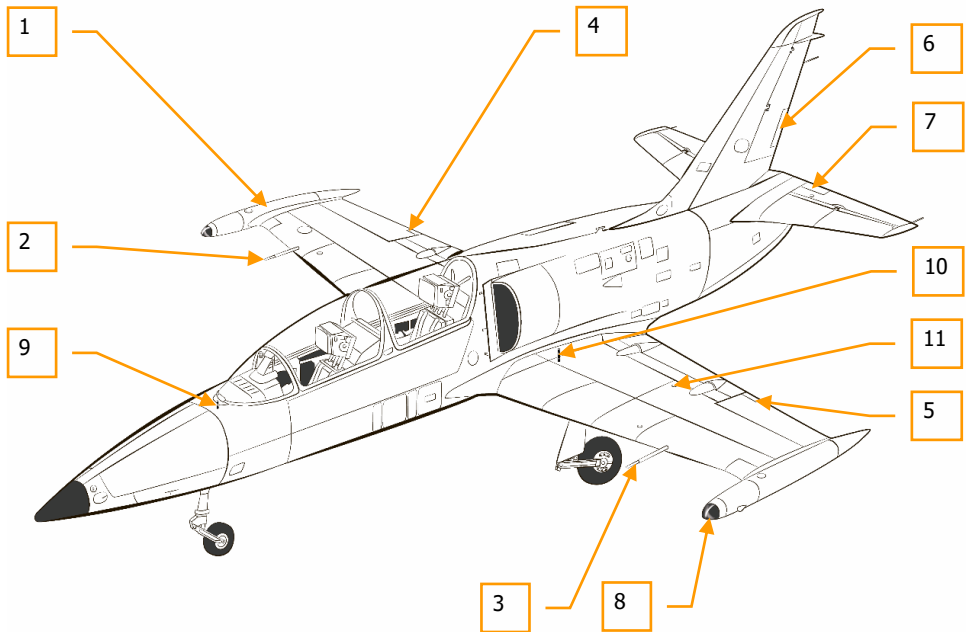

**Figure 34: Airframe details**

1. Wingtip fuel tanks
2. Primary pitot tube
3. Backup pitot tube
4. Aileron trim tab (balance tab only)
5. Aileron trim tab
6. Rudder trim tab
7. Elevator trim tab
8. Landing and taxi lights
9. Mechanical pointer of nose gear position
10. Mechanical pointer of main gear position
11. Mechanical pointer of flap position

## Airframe

The airframe consists of fuselage, wing and empennage.

The **fuselage** is a semi-monocoque, framed construction.

To ease operational service, the fuselage is divided into two parts: front and rear.

The front part consists of three sections: the fuselage nose, a sealed section with the cockpits and a section where the fuel tanks are installed. In the fuselage nose, the radio electronics and special equipment compartment is located, which houses RSBN-5S antennas, SRO-2M IFF airplane transponder blocks, R-832M radio, RKL-41 automatic direction finder, RSBN-5S unit, oxygen tanks and 12SAM-28 battery. The bottom part of the compartment contains a cutout for the nose gear bay. On the lower cover of the fuselage nose, the SRO-2M IFF antenna for Frequency Range III and the radioisotope icing sensor (RIO-3) are installed.

In the sealed cabin compartment, the RSBN-5S unit, the RV-5 radar altimeter and the MRP-56P marker beacon receiver, as well as antennas for the RKL-41 automatic direction finder, RV-5 radar altimeter and MRP-56P marker radio beacon receiver are installed.

In the tail part of the airplane, the AI-25TL engine is mounted.

The **empennage** is designed to provide directional and longitudinal stability and control of the airplane. It's a classic design, with trapezoidal-shaped vertical and horizontal stabilizers and attached to the top tail section of the fuselage.

It includes horizontal and vertical stabilizing surfaces.

The vertical ones are a fin and a rudder.

The fin provides directional stability and the rudder directional control.

The rudder can be deflected 30° in both directions. It has a trim tab to reduce the hinge moment.

The white navigation light is installed on the trailing edge of the fin.

Horizontal stabilizing surfaces consist of a horizontal stabilizer and an elevator. They are responsible for longitudinal stability and control respectively.

The elevator consists of the left and right parts. It can be deflected by 30° upwards and 20° downwards.

The **wing** is designed to create lift, provide lateral stability and control as well as for placing units and various equipment. The wing is non-swept, trapezoidal with permanent (non-removable) wingtip tanks. The wing is equipped with ailerons and flaps. The maximum aileron deflection angle is ±16°.



**Figure 35: Aerodynamic controls**

1. Flap
2. Aileron
3. Fin
4. Rudder
5. Horizontal stabilizer
6. Elevator

The main landing gear legs are attached to the wing and retract into the wing towards the fuselage.



**Figure 36: L-39 gears**

The air brakes are located on the lower side of the wing and can be manually extended by the pilot. When reaching Mach  $0.78 \pm 0.02$ , the air brakes will be extended automatically. The maximum deflection angle of the air brakes is  $55^\circ$ .



**Figure 37: Air brakes**

Universal hardpoints are located on the bottom side of the wing. Two pitot-static pressure system tubes are installed on the leading edges of the wing - the primary pitot tube on the right side and the emergency pitot tube on the left side.



**Figure 38: Pylon, pitot tube and wingtip tank**

Permanent (non-removable) fuel tanks with a capacity of 100 liters each are mounted on the wingtips. Landing and taxi lights are installed in the nose parts of the tanks.

The navigation lights are located on the wingtip tanks - red on the left side and green on the right side.

## Cockpit

The cabin is designed to accommodate two pilots, two ejection seats and related emergency equipment, various blocks, components and devices that control the airplane, the engine and various other systems. Each cockpit is covered by a canopy.

Both the front and the rear cockpit are pressurized.

The canopies provide the pilots with the necessary visibility from the cockpits, make the cabin aerodynamic and seal it. The two canopies together consist of four parts: windshield, an openable part of the front cockpit, mid-panel and openable part of rear cockpit.

An anti-icing system is installed on the airplane to prevent icing of the windshield.



**Figure 39: Both canopies in the open position**

For practicing flight under instrument flight rules (IFR), the front cockpit is equipped with a special IFR hood, attached to the movable part of the front cockpit. The hood can be controlled from both cockpits. Normally, the front pilot raises and lowers the hood with his left hand (in this simulation with a button). The rear cockpit contains a special handle to do this on the left side of the cockpit.



Figure 40: Front cockpit with IFR hood lowered

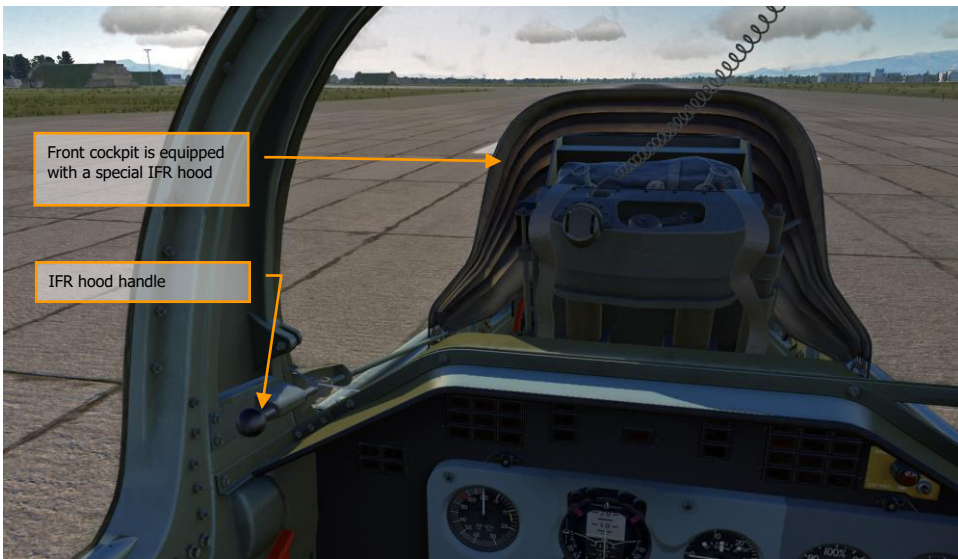

Figure 41: Lowered IFR hood, rear cockpit view

***Important: If the hood was raised from the rear cockpit, it can only be lowered from the rear cockpit!***

The locks for the movable part of the canopy are opened and closed with the help of a handle located on the left side of the cockpit. The lock is closed by moving the handle forward and opened by moving the handle backward. The "CANOPY UNLOCKED" indicator on the warning lights panel signals if the locks are closed or not. When closed, the handles have to be behind the red mark and the "CANOPY UNLOCKED" indicator is off. If the canopy is not locked, the "CANOPY UNLOCKED" signal lamp illuminates continuously (not blinking).



**Figure 42: Canopy handle**

The movable parts of the canopy are equipped with an emergency pyrotechnical jettison system which provides both emergency canopy jettison without seat-ejection and canopy jettison followed by ejection. To jettison the canopy without ejecting, it is necessary to deflect the handle, located on the right side of both cockpits, downward. The locks will be opened and the movable parts of the canopy detach from the cockpit. Canopy jettison followed by ejection can be done by pulling the double handle on the ejection seat.



Figure 43: Emergency canopy jettison handle



## VS 1-BRI Ejection Seat

The VS1-BRI ejection seat is intended to be placed inside the cockpit and eject the pilot in case of an emergency. To eject, the pilot has to pull the double handles located at the front of the seat in the middle, after that all systems trigger automatically up until the deployment of the parachute. The pilots can be ejected in any sequence. When it is necessary to leave the airplane after manual canopy jettison, the pilot in the rear cockpit ejects first (in order to avoid injuries from exhaust powder gases of the URM-1 front cockpit ejection seat rocket booster). To exclude the possibility of simultaneous ejection from both cockpits with consequent collision of the ejection seats, there is a blocking system.

If the first crew member was not ejected (for some reason), the second crew member can override blocking by the ejection unlock switch, labeled "UNLOCK EJECT". These switches are located on the right panel of both cockpits. They are not functional in this simulation.

## Hydraulic System

The hydraulic system consists of the utility and emergency systems.

The utility hydraulic system is used for:

- landing gear extension and retraction;
- flaps extension and retraction;
- air brake extension and retraction;
- main landing gear braking.

The utility hydraulic system is controlled by buttons, switches and valves located in both cockpits of the airplane. The utility hydraulic system controls in the rear cockpit are the COMMAND ones (this means that they can override the controls in the front cockpit).

The emergency hydraulic system is used for:

- emergency gear extension;
- emergency flaps extension to "LANDING" position;
- emergency extension of ram air turbine;
- emergency braking;
- emergency gear retraction in case of engine self-stop.

The emergency hydraulic system is controlled by mechanic valves, located on the right panels in both cockpits. There is no priority in operation between them.

Nominal liquid pressure in the utility and emergency hydraulic systems is 150 kg/cm<sup>2</sup>.



**Figure 44: Hydraulic pressure gauges**

Pressure in the emergency and utility hydraulic systems is monitored with the help of double-pointer pressure gauges with 0-200 kg/cm<sup>2</sup> scales, installed on the right panel in each cockpit. The left pointer indicates pressure in the utility hydraulic system and the right one in the emergency system.

## Utility Hydraulic System

### Landing Gear

The landing gear is needed for takeoff, landing and maneuvering the airplane on the airfield. The front landing gear leg is mounted in the fuselage nose and retracts forward in the corresponding bay. The two main landing gear legs are mounted inside the wing and retract completely into the middle section of the wing towards the fuselage. In the extended position, the main landing gear bays are covered with landing gear doors.

The main landing gear wheels are being automatically decelerated during retraction. The nose gear wheel is not equipped with brakes and can freely rotate to both sides at an angle of  $\pm 60^\circ$ .

There is a lock to prevent possible landing gear retraction on the ground.

The nose gear strut has an end switch which blocks the retraction circuit when the nose gear is under load.

**Important: If the landing gear lever is in the UP (retracted) position, the gear will not be retracted while on the ground, but during takeoff, after the nose wheel is lifted, the strut will become unloaded and the nose gear will be retracted!**

Landing gear extension and retraction is controlled by electrical switches located on the left side of the instrument panels in both cockpits. In the front cockpit it is a two-position switch. To retract the gear, set it to the UP position, to extend the gear - to the DOWN position.

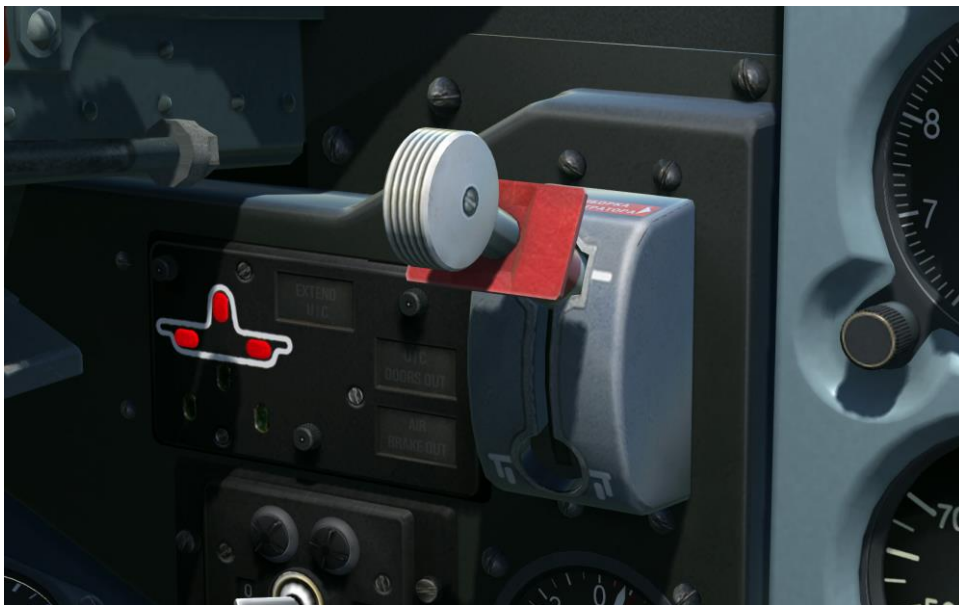

**Figure 45: Landing gear lever, front cockpit**

The landing gear lever in the rear cockpit has three positions. In addition to the UP (retracted) and the DOWN (extended) positions, it has a neutral position.

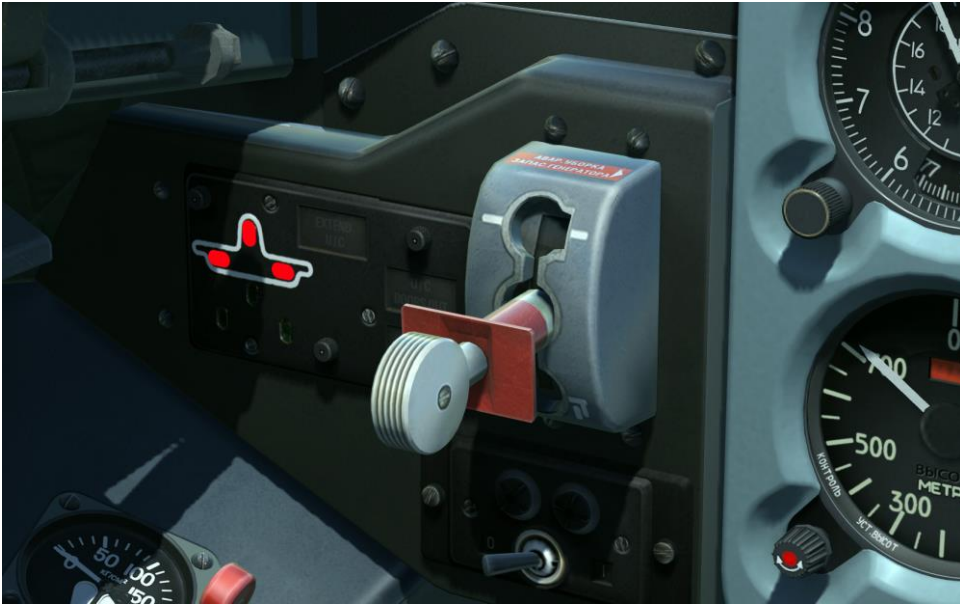

**Figure 46: Landing gear lever, rear cockpit**

**Important: The L/G control lever in the rear cockpit is a command one. The landing gear can be controlled by the switch in the front cockpit only if the switch in the rear cockpit is in neutral position!**

Indication for landing gear and gear door position is identical in both cockpits. For that purpose, there is a landing gear position indicator panel, located in the bottom left part of the instrument panel in both cockpits, as well as mechanical pointers. The nose gear mechanical pointer is located on the fuselage nose in front of the windshield and the main landing gear mechanical pointers are on the wings. When the landing gear is extended, the mechanical pointers are fully elevated. Conversely, when the landing gear is retracted, the mechanical pointers are fully hidden inside the fuselage and wings.

## Main Landing Gear Braking System

This system is intended for simultaneous and differential braking and to automatically unlock the brakes if they are locked up during braking or skidding.

The landing gears brake simultaneously when the wheel brake lever, located on the stick in both cockpits, is pressed.

Differential braking is achieved by pressing the brake lever and deflecting the pedals at an angle of  $(18\pm 2)^\circ$  to  $(40\pm 2)^\circ$ . If the pedals are deflected at an angle less than  $(18\pm 2)^\circ$ , differential braking is not performed.

The wheel brakes are released with the release of the brake lever.

**Important: The brake lever in the rear cockpit is a command one. When this lever is pressed, the brakes cannot be controlled by the brake lever in the front cockpit!**

Brake pressure is indicated by double-pointer pressure gauges installed in both cockpits on the bottom center console. These pressure gauges will normally show the same pressure in the left and right wheel brakes.

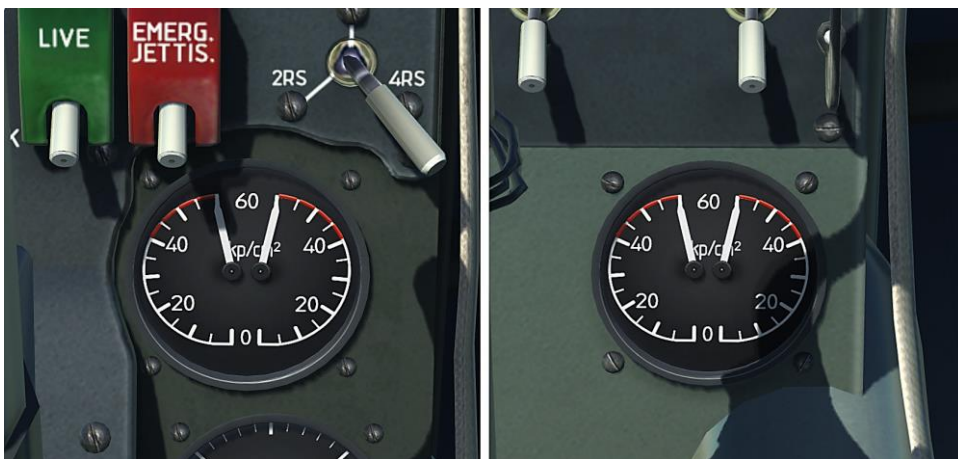

**Figure 47: Double-pointer pressure gauge in front (left) and rear (right) cockpits**

There is a parking brake as well, which latches the main landing gear wheels when the airplane is parked. The parking brake handle is located on the left panel in the front cockpit only. To enable the parking brake, it is necessary to move the handle all the way forward until it stops. To release the parking brake, move the handle to the center position. The parking brake operates from emergency hydraulic pressure.

## Flaps

The L-39C has large mechanical double-slotted flaps on the wings. Their purpose is to improve takeoff and landing characteristics of the airplane by increasing lift and partly the wing area.

The flaps are controlled by three buttons, located on the left panel in both cockpits. The top one sets the flaps to the FLIGHT  $0^\circ$  position, the middle one to the TAKEOFF  $25^\circ$  position and the bottom one to the LANDING  $44^\circ$  position.

The current flap position is indicated (same for both cockpits) by three indicator lights, located on the left panel near the flap control buttons. When the flaps are retracted, the top "FLIGHT" indicator light is on, when the flaps are in takeoff position, the middle "TAKEOFF" indicator light is on, and when the flaps are in landing position, the bottom "LANDING" indicator light is on. While the flaps are retracting or extending, the corresponding button is held down after being pressed. When the flaps reach the required position, the depressed button pops back to its initial position.

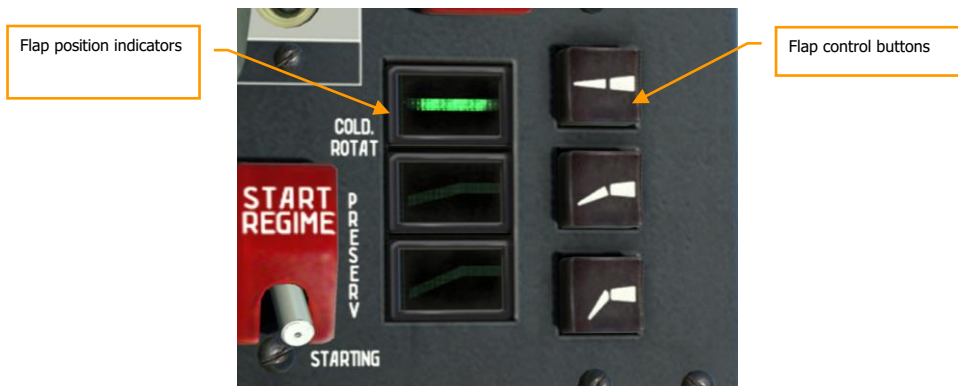

**Figure 48: Flap position indicators and control buttons**

**Important: The flap buttons in the rear cockpit are the command ones. The pilot in the rear cockpit can override flap controls in the front cockpit!**

There are mechanical flap indicators, located on the upper surface of each wing, to provide visual identification of flap position. When the flaps are retracted, the mechanical pointers are hidden in the wing: after reaching TAKEOFF position, they are raised halfway and after reaching the "LANDING" position, they are fully extended.

The extension time from FLIGHT 0° to TAKEOFF 25° position is (3±1) seconds.

The extension time from FLIGHT 0° to LANDING 44° position is (5±1) seconds. Retraction time is the same. If the pilot in due time does not retract the flaps, they will be retracted automatically at airspeeds above 310 km/h.

## Air brakes

Air brakes are used to decelerate the airplane in flight.

Extension and retraction of the air brakes is controlled by switches, located on the throttle handle in both cockpits.

In the front cockpit, the switch has two fixed positions: EXTEND and RETRACT. From the front cockpit it is also possible to extend the air brakes for a short time by pressing the switch inward like a

button, when released air brakes retract. To extend the air brakes for a longer time, it is necessary to toggle the switch to the rear position and for retraction to the front position.



**Figure 49: Air brake switch, front cockpit**

In the rear cockpit this switch has three positions: forward (air brake retraction), middle (neutral) and aft (air brake extension).

**Important: The air brake control switch in the rear cockpit is a command one. The air brakes can be controlled from the front cockpit only if the rear cockpit switch is in the neutral position!**

The current air brake position is indicated by the "AIR BRAKE OUT" indicator, located on the landing gear position indicator panel in both cockpits.

When the airplane reaches Mach  $0.78 \pm 0.02$ , the air brakes are extended automatically.

## Utility Hydraulic System Controls and Indication in Both Cockpits

### Front Cockpit



Figure 50: Utility hydraulic system controls and indication, front cockpit

### Rear Cockpit

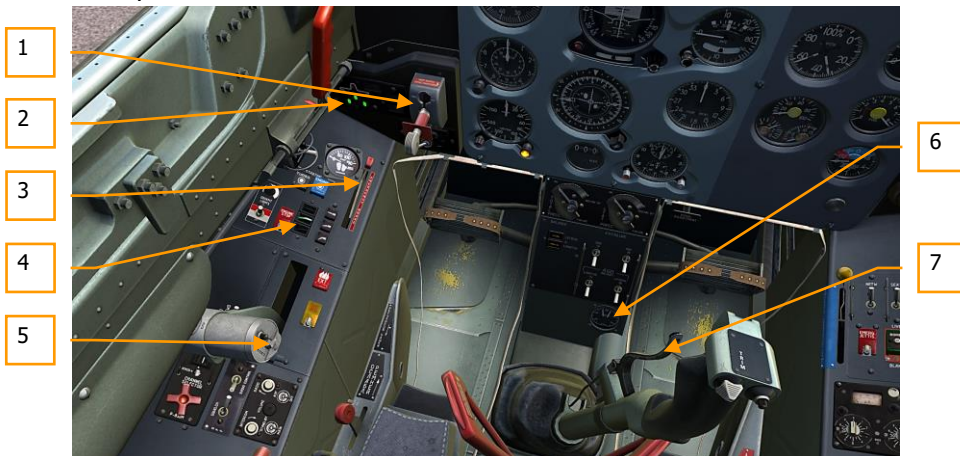
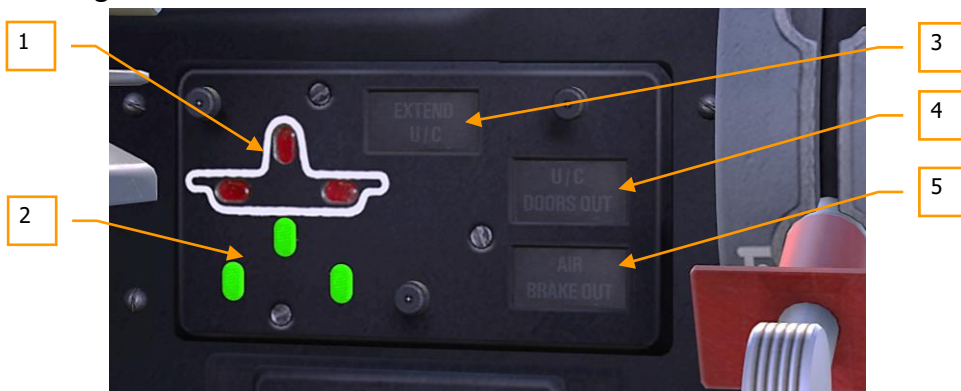

Figure 51: Utility hydraulic system controls and indication, rear cockpit



1. Landing gear lever
2. Landing gear position indicator panel
3. Parking brake handle
4. Flap control buttons and flap position indicators
5. Air brake switch
6. Double-pointer pressure gauge
7. Wheel brake lever

### Landing Gear Position Indicator Panel



**Figure 52: Landing gear position indicator panel**

1. Three red lamps – indicate that gear is retracted (UP).
2. Three green lamps – indicate that gear is extended (DOWN).
3. EXTEND U/C lamp – illuminates if during landing approach the flaps are extended to landing position, but the gears are still retracted (when this lamp is on, an aural warning horn is heard)
4. U/C DOORS OUT lamp – illuminates during landing gear extension and retraction (in case of emergency gear extension, the gear doors do not close and the UC DOORS OUT lamp continues being on)
5. AIR BRAKE OUT – indicates that air brakes are extended.

## Emergency Hydraulic System

The emergency hydraulic system is being pressurized (charged) automatically while the engine is running and the landing gear is extended. To pressurize the emergency hydraulic system in flight with retracted landing gear, it is necessary to open the valve connecting the main and emergency hydraulic systems, by moving the corresponding handle on the right control panel.

During flight, it is necessary to check the emergency system pressure periodically and, if needed, pressurize it to 150 kg/cm<sup>2</sup> by moving the valve lever, connecting both systems, backwards. Landing

gear, flaps and ram air turbine can be extended in case of emergency if the pressure in the emergency hydraulic system is at least 105 kg/cm<sup>2</sup>. If the pressure in the emergency hydraulic system falls to 100±5 kg/cm<sup>2</sup>, the HYD. SYST. FAIL flashes on the warning lights panel in both cockpits.

To avoid a pressure drop in the emergency hydraulic system in case of a pressure drop in the utility hydraulic system, system connection valves have to be closed in both cockpits.



**Figure 53: Emergency hydraulic system valves**

1. Emergency gear extension valve.
2. Emergency flaps extension valve.
3. Emergency ram air turbine (RAT) extension valve.
4. Valve interconnecting main and emergency systems.

For emergency flap extension it is necessary to move the emergency flap extension valve lever, located on the right panel in the front or rear cockpits, all the way back. Landing gear extension is monitored by corresponding lights and mechanical pointers. In case of emergency landing gear extension, the gear doors are kept open and the U/C DOORS OUT (gear doors are opened) indicator light remains on.

With the help of the emergency hydraulic system, the flaps extend only to the landing position (44°). When emergency flap extension is used, the trim tab on the left elevator does not deflect automatically.

A landing approach with retracted gear and flaps extended to landing position (44°) is accompanied by the EXTEND U/C indicator light on the landing gear position indicator panel and a horn.

For emergency ram air turbine extension, it is necessary to move the emergency ram air turbine extension lever, in the front or rear cockpit, backward until it stops.

To retract the gear in case of an emergency where the engine stops, it is necessary to set the landing gear lever to the UP (retracted) position and to the right for 1-2 seconds in the front or rear cockpit.

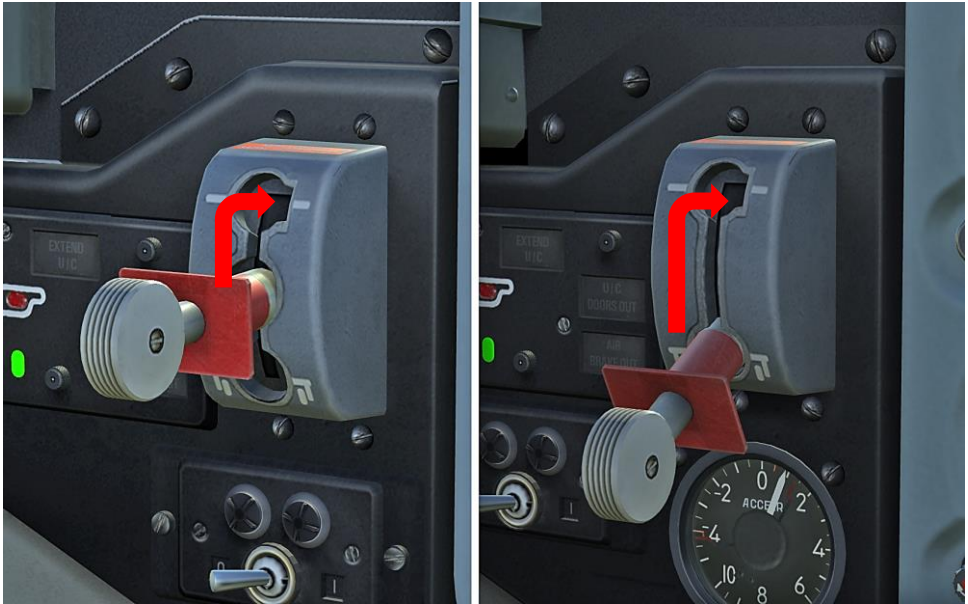

**Figure 54: Emergency gear retraction, rear (left) and front (right) cockpit**

## Emergency Main Landing Gear Braking

To perform emergency braking, it is necessary to move the emergency brake valve lever, located on the left panel in the front and rear cockpit, backward. While performing emergency braking, it is impossible to achieve differential braking (perform a turn) and the wheels are not automatically unlocked when skidding.

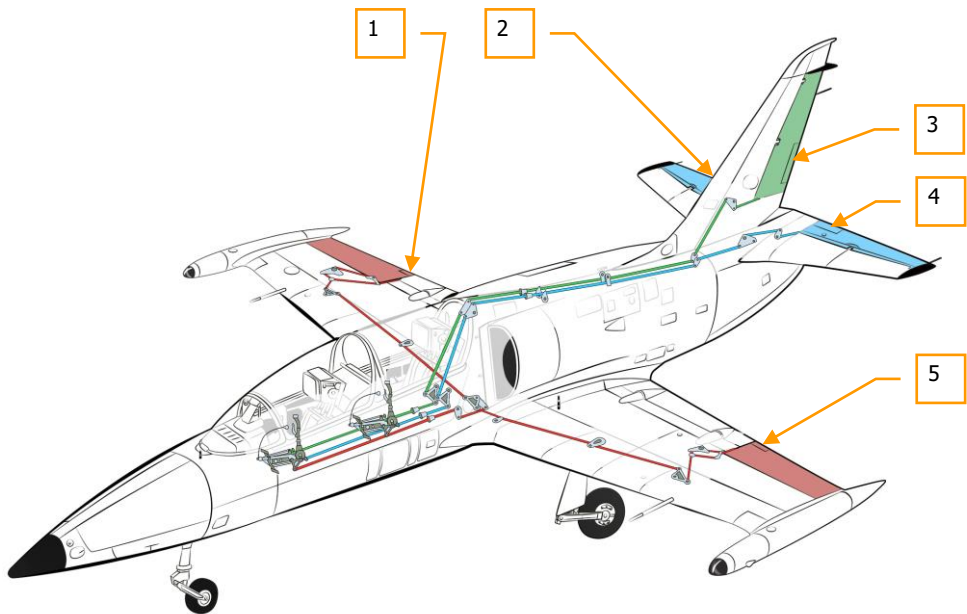

**Figure 55: Emergency main landing gear braking lever, front (left) and rear (right) cockpit**

Brake pressure is indicated by a pressure gauge, installed on the bottom center console in the front cockpit only.

# Aircraft Controls

Airplane controls include elevators, ailerons, rudder control systems and systems controlling elevator and aileron trim.



**Figure 56: Aircraft controls**

1. Aileron trim tab
2. Elevator trimmer (not visible)
3. Rudder trim tab
4. Elevator trim tab
5. Aileron trimmer

The elevator and ailerons are controlled by the sticks installed in both cockpits of the airplane. Control sticks are connected to elevator and ailerons with tube rods, intermediate levers and rockers. The rudder is controlled by pedals, which are connected to the rudder with tube rods, intermediate levers and rockers.

All control surfaces of the airplane are equipped with trim tabs to reduce hinge moments on the control surfaces. The trim tab on the right aileron deflects depending on aileron deflection angle and does not have an electric motor. The trim tab on the left aileron has an electric motor, which is remotely controlled by a pushbutton on the stick. Therefore, the trim tab on the left aileron is an aileron trimmer.

The trim tab on the rudder does not have an electric motor and deflects depending on rudder deflection angle.

Trim tabs on the left and right sides of the elevator have electric motors. The one on the right side is remotely controlled by the pushbutton on the stick. This trim tab is an elevator trimmer.

The trim tab on the left side of the elevator deflects automatically 15° downward when the flaps are extended in the landing position.

Elevator and aileron trimmers are controlled remotely with the help of electric motors. Trimmer control buttons are located on the sticks. Neutral aileron and elevator trimmer position indicators are located on the center console in both the front and the rear cockpit. In the rear cockpit, instead of an elevator trimmer position indicator, the neutral elevator position indicator light is installed.

# Trimmer Controls in the Front and Rear Cockpit

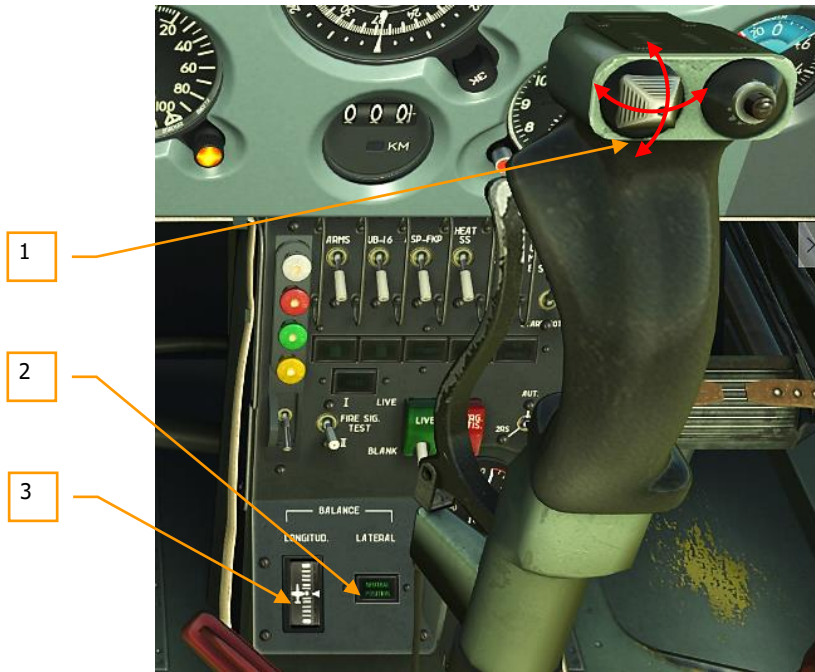
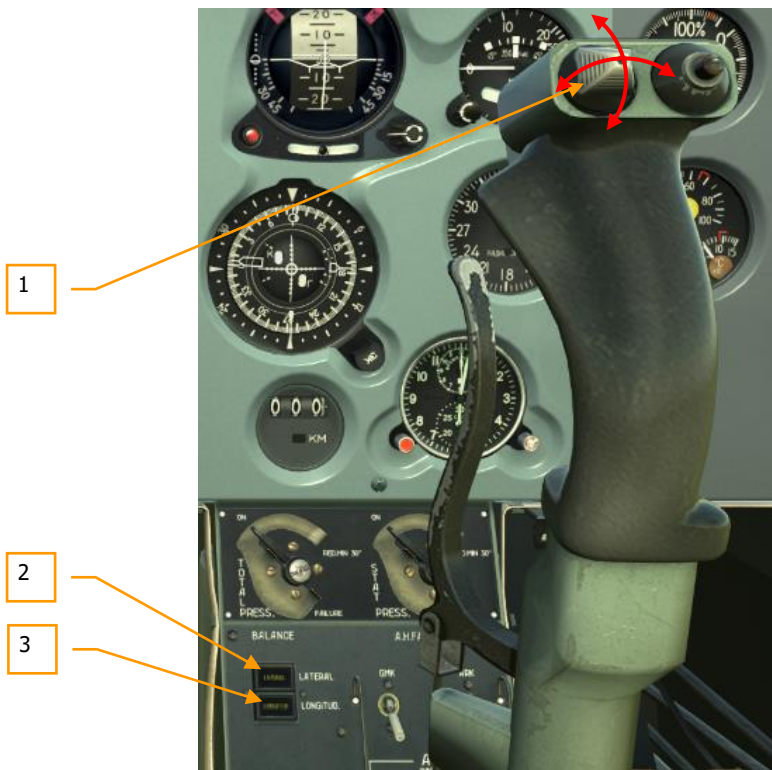

Figure 57: Trimmer controls, front cockpit



**Figure 58: Trimmer controls, rear cockpit**

1. Trimmer control button
2. Neutral aileron trimmer position
3. Neutral elevator trimmer position



## Environmental Control System

The environmental control system is used for sealing the canopy visor and the parts of the canopy that can be opened.

Sealing the cockpit is performed with the help of the cockpit pressurization and ECS handle. The cockpit, after closing the canopy, is locked by moving the lever all the way forward in the front or rear cockpit. Unsealing is done by moving the lever in the opposite direction. The levers are located on the right horizontal panel in both cockpits.

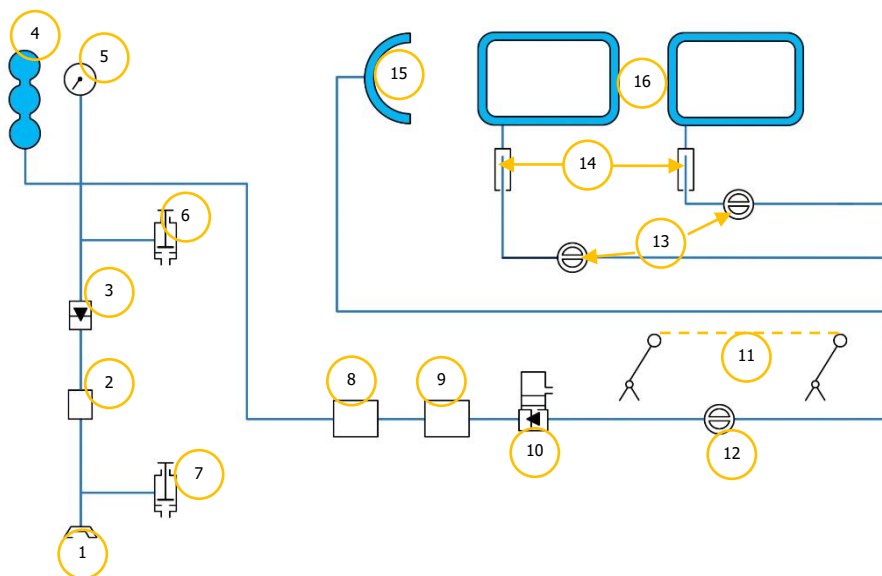

**Figure 59: Environmental control system diagram**

1. Pressurization (charge) port
2. Filter
3. Check valve (= non-return valve)
4. Tank
5. Pressure gauge
6. Air bleeder valve, bleeds air from the system

7. Air bleeder valve, bleeds air from the pressurization hose
8. Pressure reducing valve
9. Pressure reducing valve
10. Combine valve
11. Cockpit pressurization and ECS handle
12. Sealing valve
13. Sealing valves for parts of the canopy that can be opened
14. Telescopic connections
15. Windshield sealing hose
16. Sealing hoses for parts of the canopy that can be opened

In case of the canopy locks opening without prior unsealing with the help of the sealing handle or when ejecting, pressure from the hoses is bled automatically. Canopy opening without depressurization of sealing hoses is not recommended due to the possibility of the canopy detaching from the hinges.

## Air Conditioning System

The air conditioning system is developed to sustain the required temperature and pressure in the cockpit as well as for cockpit ventilation. The air conditioning system together with the pressurized cockpit, oxygen equipment, monitoring and control units form the airplane's altitude equipment.

The airplane cockpit is of ventilation type. Required air pressure in the cockpit is provided by feeding it with compressed air from the engine compressor. When fed into the cockpit, the air ventilates, warms or cools it and is then vacated. Cockpit sealing and ventilation occurs after moving the cockpit pressurization and ECS handle all the way forward in both the front and rear cockpit. As a result, after 30 seconds the AIR CONDIT OFF indicator on the right caution & advisory lights panel in both cockpits goes out. The AIR CONDIT OFF indicator is a blinker. It informs the pilot about the position of the air supply shut-off valve. If the indicator is blinking, the valve is closed, if the indicator is off, the valve is open. The shut-off valve is controlled by the cockpit pressurization and ECS handle. The valve can be controlled only if the air conditioning emergency shut-off switch in the rear cockpit, labeled AIR COND, is in the neutral position.

When the temperature regulator is in emergency mode, the AIRCONDIT EMERG (emergency conditioning) indicator will be lit on the caution & advisory lights panel. The temperature regulator emergency functionality is not implemented in this simulation and thus the emergency indicator will be lit only while the CHECK button is held depressed.

The "altitude" in the cockpit and the air pressure difference is monitored by the cockpit altitude and pressure difference gauges ("UVPD" in Russian). A UVPD is installed in each cockpit. In case of a positive or negative pressure difference in the cockpit, and if the cockpit is unsealed on altitudes higher than 2000 m, the CABIN PRESSURE indicator on the warning lights panel in both cockpits will come on. This indicator is a blinker.

Some functions of the ECS, such as automatic cockpit temperature regulation, individual flight suit automatic temperature regulation and individual air diffusers are not implemented in this simulation.

The cockpit air temperature control panel is installed on the right console in the front cockpit. Behind this panel, the cabin air conditioning control switch (OFF – HEAT – COOL – AUTOMATIC) and the cabin air temperature controller rheostat are located. Flight suit ventilation valves regulate the air supply to the flight suits and are located on the left panels in both cockpits.



**Figure 60: Flight suit ventilation controller**

Individual air showers are installed in both cockpits on the right hand side of the instrument panel. All controls are animated.

Air system and environmental control system controls and indication in the front and rear cockpits



Figure 61: Air system and environmental control system controls and indication, front cockpit



Figure 62: Air system and environmental control system controls and indication, rear cockpit

1. Cockpit pressure gauge (UVPD)
2. Cockpit pressurization and ECS handle
3. Individual diffuser and flight suit temperature control panel
4. Individual air shower valve (diffuser)
5. Cockpit air temperature control panel
6. AIR COND circuit breaker

# Fuel System

The fuel system of the airplane is used for fuel allocation and providing smooth engine operation throughout the operating range of altitudes and speed.

The fuel system consists of the main fuel system and wingtip tanks' system.

The main fuel system incorporates five fuselage tanks with a total capacity of 1100 liters (825 kg). To increase the range of flight, two wingtip tanks are present with a capacity of 100 liters each. Total fuel load is 975 kg.

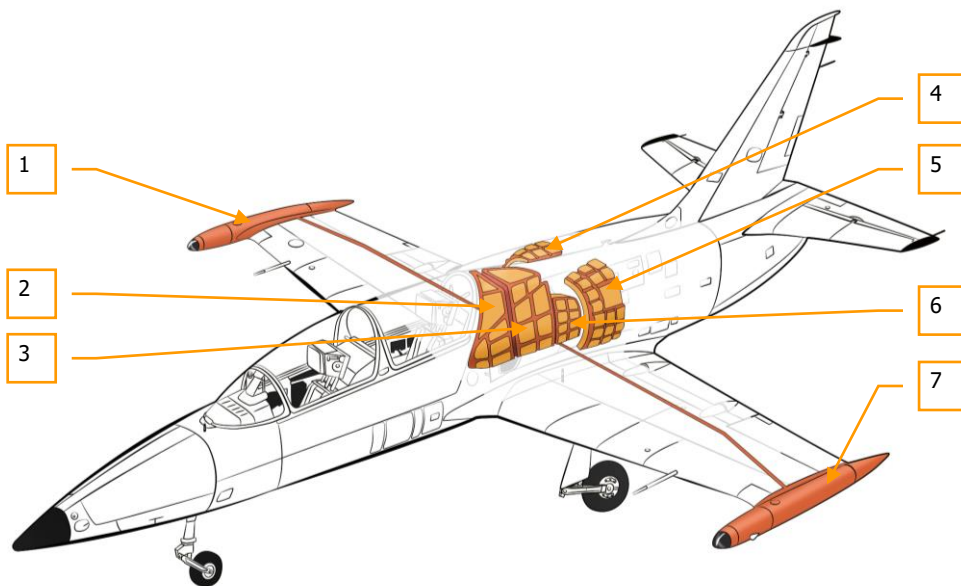

**Figure 63: Fuel tanks**

1. Right wingtip tank (100 l)
2. Fuselage tank #1 (260 l)
3. Fuselage tank #2 (365 l)
4. Fuselage tank #3 (135 l)
5. Fuselage tank #4 (135 l)
6. Fuselage tank #5 (205 l), feed tank
7. Left wingtip tank (100 l)

The fuel reservoir is used to supply the engine with fuel while flying with negative G's. Its capacity is 10.5 liters. Flying with negative G's for more than 20 seconds is not allowed. The accumulator has to be refilled by flying horizontally for at least 20 seconds, before flying again with negative G's.

To shut off fuel flow from the tanks into the fuel pipeline, the fuel shut-off valve has to be used. This valve is controlled with the help of levers, located on the left side of both cockpits. In the forward position, the fuel shut-off valve is opened.



**Figure 64: Fuel shut-off valves in both cockpits**

## Fuel Use Order

The order of fuel consumption has to keep the airplane's center of gravity within specified operating limits. When fully refueled (1300 liters), fuel is initially consumed from the fuselage tanks. When 575-625 kg remains in the fuselage tanks, this can be monitored on the fuel gauge; fuel is consumed from the wingtip tanks. It takes 15 minutes to use all the fuel from the wingtip tanks. The fuel gauge shows the total fuel in kilograms remaining in the fuselage fuel tanks.

This gauge is designed for measuring the fuel amount and indicating the remaining amount of fuel reserve.

To enable the gauge, it is necessary to turn on the BATTERY and ENGINE switches on the front cockpit main CB panel. After 1-2 minutes, the pointer should show the actual fuel amount in the fuselage fuel tanks. Fuel gauges are installed on the instrument panels in both cockpits.

When the SPT-40 inverter fails, the fuel oil pressure gauges do not operate. To enable capacitive fuel gauge operation, it is necessary to enable the ENGINE INDICAT. EMERG switch on the right panel in the front cockpit. The zero position on the scale corresponds to 37 kg fuel in the fuselage tanks.

After running out of fuel from the wingtip tanks, fuel from the fuselage fuel tanks is consumed.

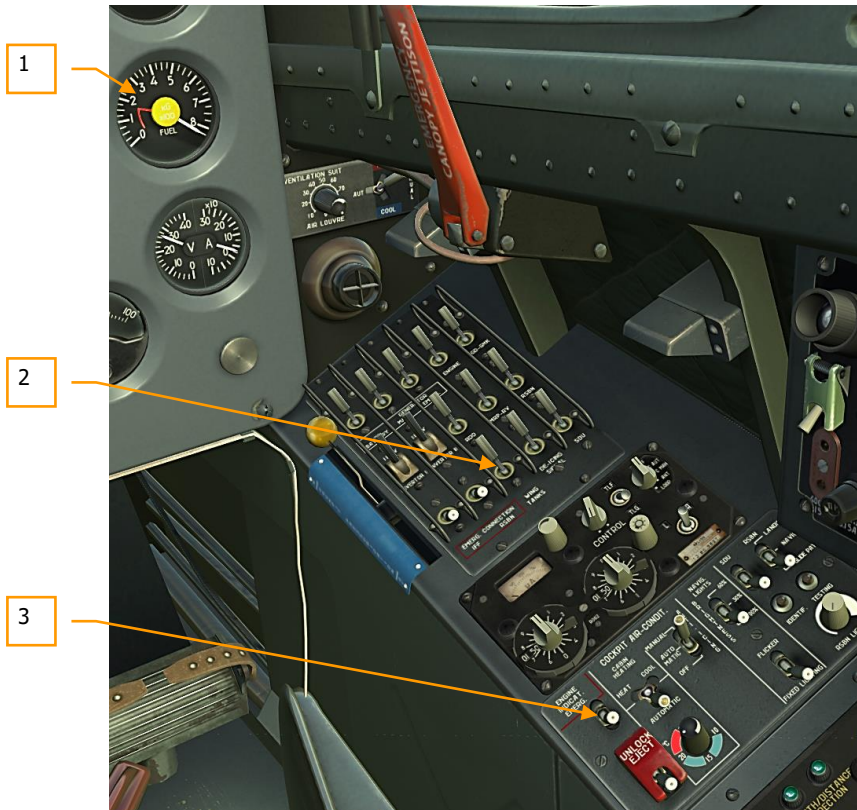

**Figure 65: Fuel management controls**

1. Capacitive fuel gauge
2. WING TANKS circuit breaker
3. ENGINE INDICAT. EMERG (Engine gauges emergency power supply) switch

## Indicators

- 150 KG FUEL indicator on the warning lights panel in both cockpits, signaling reserve amount of fuel in the fuselage tanks; this indicator is a blinker.
- DON'T START indicator on the warning lights panel in both cockpits, signaling fuel pressure drop after fuel pump (blinks); this indicator is a blinker.



- FUEL FILTER indicator on the caution & advisory lights panel in both cockpits, showing pressure difference on the fuel filter (the filter is designed to clean fuel from mechanical impurities). This indicator operates in continuous mode.
- WING TIP TANKS indicator on the caution & advisory lights panel in both cockpits, which goes out when fuel pressure in the wingtip tanks increases and comes on when the wingtip tanks are empty. When the wingtip tanks run out of fuel and the WING TIP TANKS indicator illuminates, it is necessary to switch off the WING TANKS automatic circuit breaker on the main CB panel in the front cockpit. This indicator operates in continuous mode.

## Engine Fire Extinguishing Equipment

The engine fire extinguishing equipment is designed to extinguish fire in the fire hazardous engine zone. This zone includes the fuel assembly of the engine, the combustion chamber and the gas chamber housing.

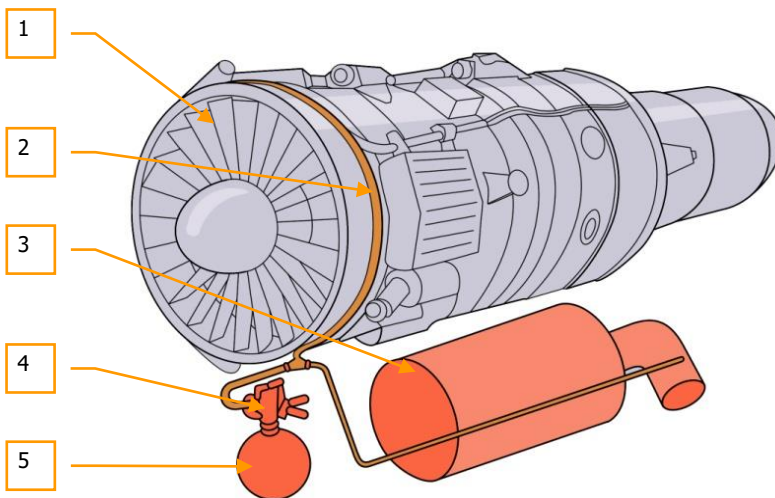

**Figure 66: Engine fire extinguishing equipment**

1. AI-25TL engine
2. Distribution manifold / spray ring
3. Sapphire-5 APU
4. Bottle head with extinguisher valve and pyrotechnical charges

#### 5. Fire extinguisher bottle (tank)

The fire extinguishing equipment of the L-39 consists of the SSP-FK fire detection system, fire indication and fire extinguishing systems.

## Fire Detection and Indication System

The fire detection and indication system is designed so that a light signals when a fire occurs. It consists of six thermal sensors in the engine compartment and FIRE warning lights on the emergency panels in the front and rear cockpit.

### Fire Sensors

Six DTBG thermoelectric fire sensors are installed in the engine nacelle for fire detection. The six sensors are split into two groups with three sensors each. The sensors are located in the most dangerous places in the engine compartment: APU, generator, left & right igniter, waste can/FCU, air-starter/FCU.

When the temperature in the engine compartment reaches 200 °C or increases at a rate of more than 4 °C per second, a relay closes and the FIRE warning lights illuminate. When the fire is extinguished or when the temperature in the engine compartment decreases rapidly, the warning lights extinguish and the warning circuit is rearmed.

### Fire Warning Circuit Test Switch

Before every flight it is necessary to check if the thermal sensors operate correctly. Correct sensor operation can be verified with the spring-loaded three-position FIRE SIG TEST / TEST SSP switch, installed on the center pedestal in the front cockpit. The positions "I" and "II" are for testing the first and second sensor group respectively. To check the sensors, one first has to press and hold the switch in position "I" to test the first sensor group. The FIRE warning light should illuminate while the switch is held and go off when the switch is released. This procedure should be repeated for position "II" to test the second sensor group. Note that this test only tells you that both sensor channels are electrically working and nothing about the correct setting of the activation threshold for each channel (WHEN the FIRE warning light comes on). This test also ensures that the fire detection system resets correctly after a fire was extinguished.

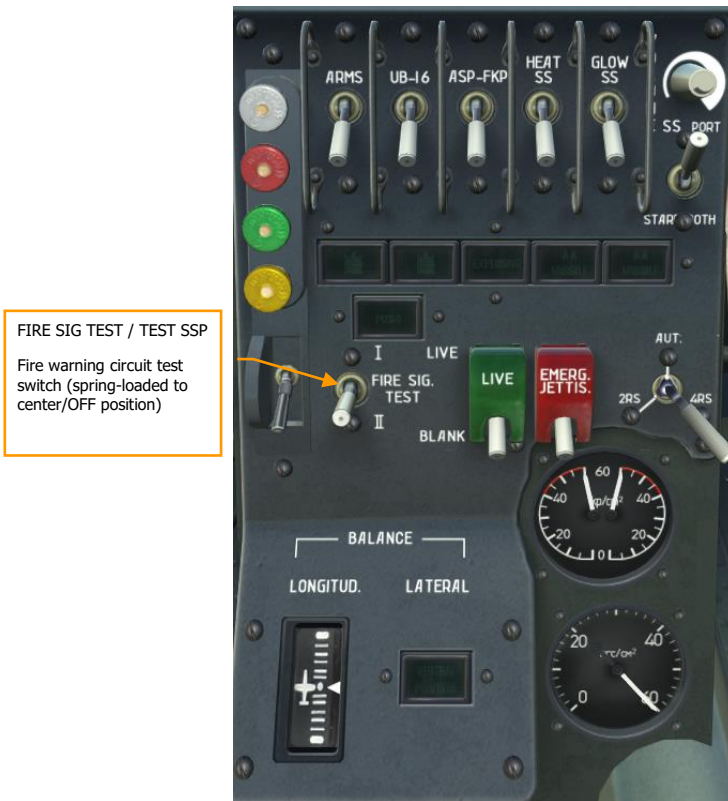

**FIRE SIG TEST / TEST SSP**  
 Fire warning circuit test switch (spring-loaded to center/OFF position)

**Figure 67: Fire warning circuit test switch**

## Fire Warning Light

A red warning light labeled **FIRE** in the warning panel in both cockpits illuminates whenever the fire sensors detect fire or overheat. In case of fire, both the fire warning light and the red master caution lights are blinking. The master caution lights are located above the instrument panel in both cockpits. The **FIRE** warning light is a blinker.

## Fire Extinguishing System

The fire extinguishing system consists of the fire extinguisher bottle and the tubes for distribution of the extinguishing agent. The tubes form a spray ring and spray bar and contain little holes located in special areas to allow spraying of critical items in the engine compartment.

Two pyrotechnical charges blow open the valve of the fire extinguisher bottle, thus releasing its contents to be distributed to the manifold. For system operation at least one pyrotechnical charge must be fired.

## Fire Extinguisher Button

In case of fire, it is necessary to press the fire extinguisher button, guarded by a red cover labeled EXT (for "extinguish") and located on the forward part of the left console in both cockpits. When one of the buttons is pressed, two pyrotechnical charges are electrically fired simultaneously and the fire extinguisher valve is opened. When the fire is extinguished, the fire warning light turns off.

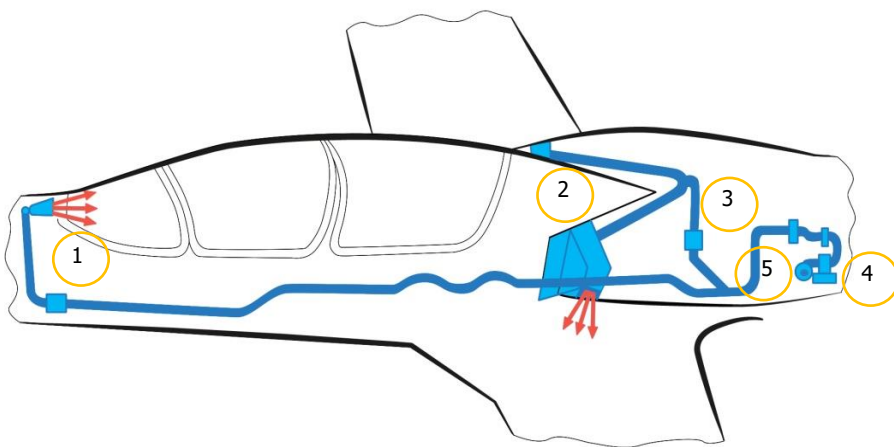

**Figure 68: Fire extinguisher button**

The circuit is protected by two CBs. The first one, labeled FIRE EXT is located in the nose compartment. This CB is powered by 24 V directly from the battery bus. The second one is located in the aft CB/switch panel and labeled FIRE. This CB is powered by 26 V DC. Each controls one of the pyrotechnical charges which will be fired simultaneously under normal circumstances.

## Anti-icing System

The anti-icing system is intended to protect the leading edges of the engine air intakes and the windshield from icing by using hot air from the engine.



**Figure 69: Anti-icing system**

1. Windshield air duct
2. Air ducts heating the leading edges of engine air intakes
3. Air consumption limiter
4. Shut-off valve
5. Hot air intake

The system is controlled remotely and can operate in automatic or manual (from the front cockpit only) modes. The modes are selected with the de-icing mode switch labeled ANTI-ICING located on the right panel in the front cockpit. It has three positions MANUAL – AUTOMATIC – OFF.

In the AUTOMATIC position, the anti-icing system is enabled by signals from the RIO-3 radioisotope icing sensor. When enabled, the DE-ICING ON indicators on the caution & advisory lights panels in both cockpits are on. The RIO-3 sensor is enabled by the DE-ICING SIGNAL CB on the main CB panel in the front cockpit. On the right console in the front cockpit there is the RIO-3 de-icing sensor heating circuit check button and a green light for monitoring the heating circuit.

The RIO-3 sensor measures radiation between an emitter and a detector. When icing is formed between the two, the detector can no longer measure radiation from the emitter, and the anti-icing system is activated.

The anti-icing system is activated before the flight when the outside temperature is below +5 °C, as well as before the flight in adverse weather conditions and night flights.

When the switch is in the AUTOMATIC position and an icing condition is detected, first the snowflake signal indicator illuminates and no later than 30 seconds after that, the DE-ICING ON indicator illuminates. After cessation of icing, the system turns off automatically: first the snowflake indicator goes out and after 30 seconds DE-ICING ON goes out as well. Both indicators are located on the caution & advisory lights panels in both cockpits. The DE-ICING ON and snowflake indicators operate in continuous mode.

In case of RIO-3 failure and the presence of icing, the anti-icing system has to be enabled manually. For that, the ANTI-ICING switch has to be set to the MANUAL position and not later than 30 seconds after that, the DE-ICING ON indicator illuminates. To turn off the anti-icing system, return the switch to the OFF position.

## Anti-Icing System Control and Indication



**Figure 70: Anti-icing system control**

1. DE-ICING SIGNAL circuit breaker
2. RIO-3 de-icing sensor heating circuit check button
3. ANTI-ICING switch

# AI-25TL ENGINE

## GENERAL SPECIFICATIONS, OPERATION PRINCIPLE AND MAIN ENGINE DATA

The AI-25TL twin-shaft turbofan engine is installed on the airplane.

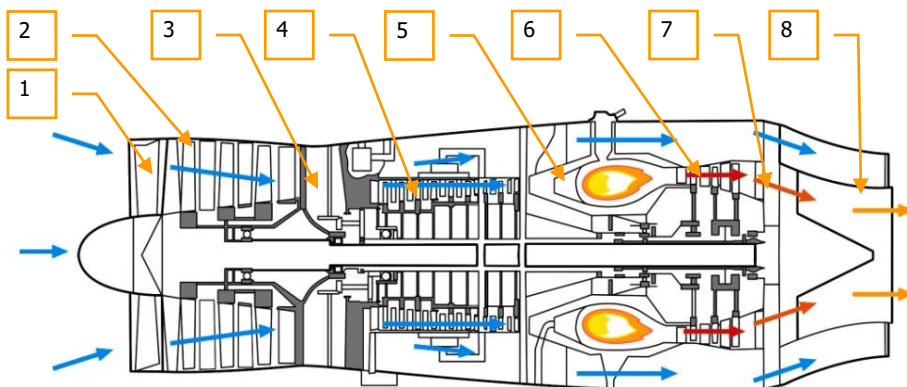

**Figure 71: AI-25TL engine**

1. Fan
2. Low pressure axial flow compressor (LPC)
3. Air flow separator
4. High pressure axial flow compressor (HPC)
5. Combustion chamber
6. Turbine rotor
7. Mixing chamber
8. Jet nozzle

Air from the atmosphere is supplied to the engine through an inlet, which consists of two air intakes, located on both sides of the fuselage.

From the inlet, air is fed through a three-stage low-pressure axial flow compressor and is then separated into two flows. The inner hot flow is fed to a nine-stage high-pressure axial flow compressor. The outer by-pass flow is directed to the by-pass exhaust through a mixer where the flow is converted into kinetic energy. The air flow from the high pressure axial flow compressor

enters the combustion chamber, where fuel is mixed with some of the air and ignited, and then moves further through the turbine into the mixing chamber and jet nozzle.

Thus the fuel-air flow, flowing through the engine, gets a significant acceleration and results in engine thrust. The AI-25TL develops around 16.9 kN (3,800 lb) static thrust during a standard atmospheric pressure of 1013 hPa (29.92 inHg) and 15 °C (59 °F) at sea level.

The AI-25TL engine is equipped with the IV-300 engine vibration measuring unit. Vibration is monitored using the IV-200 gauge, installed on the instrument panel in the front cockpit. If engine vibration exceeds 33 mm/s, the ENGINE VIBRATION indicator blinks on the warning light panels in both cockpits. To verify IV-300 functionality, press the engine vibration meter test button, labeled CHECK VIBRATION, on the left panel in the front cockpit, the gauge pointer deflects to 75-100 mm/s and the ENGINE VIBRATION indicator illuminates on the warning lights panel. The IV-200 gauge is not installed in the rear cockpit.



**Figure 72: Vibration check controls**

1. IV-300 engine vibration meter test button (labeled CHECK VIBRATION)
2. IV-200 engine vibration gauge

#### **Main engine systems:**

- Engine lubrication system
- Fuel system and engine automation
- Engine overheating protection system



- Anti-icing system
- Engine start-up system

## Engine Lubrication System

The **engine lubrication system** is intended to supply the moving parts of the engine with oil under pressure during engine operation to reduce friction and partially remove heat. Besides that, the oil washes out the smallest metal particles and protects the moving parts. The lubrication system defines the reliability of operation and service life of the engine.

Oil pressure and temperature at the engine inlet is measured by sensors. Oil pressure at 95% of HPC RPM should be not less than 3 kg/cm<sup>2</sup>, for other modes not less than 2 kg/cm<sup>2</sup>. Oil temperature should be not more than 90 °C. If the pressure exceeds these limitations, the ENG. MIN. OIL PRESS (minimum oil pressure) indicator illuminates on the caution & advisory lights panel in the front cockpit. This indicator operates in a blinking mode and is not present in the rear cockpit.

## Fuel System and Engine Automation

The **fuel system and engine automation** is intended to supply the combustion chamber with the required amount of fuel, depending on the engine operation mode. It consists of the main and emergency fuel supply systems.

The fuel pressure at the engine nozzles should not be more than 65 kg/cm<sup>2</sup>. In case of partial or complete main fuel supply system failure (combat damage), it is necessary to switch to the emergency fuel supply system by enabling the emergency fuel switch, labeled SEC. REG. and located on the left panels in both cockpits. After that, the SEC. REG. indicator will illuminate on the caution & advisory lights panels in both cockpits. This indicator operates in continuous mode.

In case of filter clogging or increased pressure difference, the FUEL FILTER signal illuminates on the caution & advisory lights panels in both cockpits. This lamp operates in continuous mode.

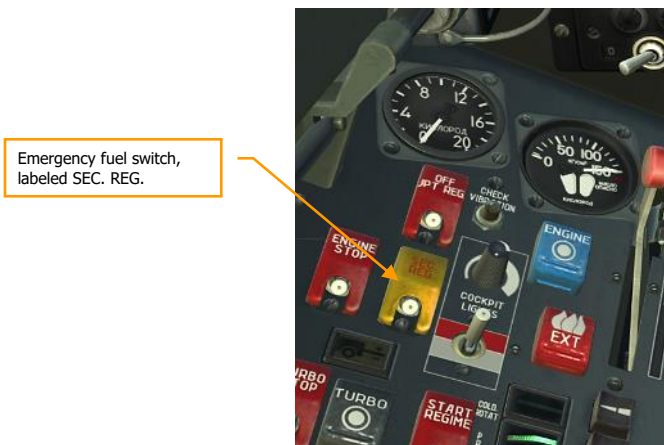

**Figure 73: Emergency fuel switch**

Fuel pressure, oil pressure and temperature have to be monitored using the three-pointer gauge, which is installed on the instrument panels in both cockpits.

Three-pointer gauge



**Figure 74: Three-pointer gauge**

1. Fuel pressure
2. Oil pressure
3. Oil temperature

To enable the gauge, it is necessary to enable the BATTERY and ENGINE circuit breakers on the front cockpit main CB panel. The oil and fuel pressure gauge pointers are set to zero on the corresponding scales after being enabled, and the oil temperature pointer shows the actual oil temperature.

In the rear cockpit, the oil temperature gauge is not operational, because there is no temperature sensor.

When the SPT-40 inverter fails, the fuel and oil pressure gauges do not work, but the oil thermometer continues to function. To enable fuel and oil pressure gauge operation, it is necessary to enable the ENGINE INDICAT. EMERG. switch, located on the right panel in the front cockpit.

## Engine Overheat Protection System

The RT-12-9 engine overheat protection system is installed on the airplane. All controls for this system are located in the front cockpit.

The system provides:

### **During ground operation (including engine check) and from takeoff roll until nose wheel lift-off:**

- When operating from the main fuel supply system, there will be an indication of exhaust gas temperature (EGT) reaching  $700\pm 15$  °C, followed by a reduction in fuel supply to prevent the temperature from exceeding  $700\pm 15$  °C.
- When operating from the emergency fuel supply system, there will be an indication only and no reduction in fuel supply when the EGT reaches  $700\pm 15$  °C.
- If the EGT continues to rise and reaches  $730\pm 15$  °C, the J.P.T. 730°C indicator comes on and the engine is shut down automatically by enabling the fuel shut-off valve.

### **During takeoff roll after nose wheel lift-off and during flight with gear or flaps extended:**

- When the EGT reaches  $700\pm 15$  °C and  $730\pm 15$  °C, there will be indications only and no engine limiting or shutdown. If the J.P.T. 700°C indicator is on during flight, fuel supply will be partially cut and engine thrust reduced only during and after retraction of the landing gear and flaps.

### **During flight with gear and flaps retracted:**

- When operating from the main fuel supply system, there will be an indication of exhaust gas temperature (EGT) reaching  $700\pm 15$  °C, followed by a reduction in fuel supply to prevent the temperature from exceeding  $700\pm 15$  °C.
- When operating from the emergency fuel supply system, there will be an indication only and no reduction in fuel supply when the EGT reaches  $700\pm 15$  °C.

- If the EGT continues to rise and reaches  $730\pm 15^{\circ}\text{C}$ , the J.P.T.  $730^{\circ}\text{C}$  indicator comes on, while operating from main or emergency fuel supply system. In contrast to ground operation, there will be no immediate engine shutdown when this indicator illuminates in the air.
- If the J.P.T.  $730^{\circ}\text{C}$  indicator was on during flight, even if the EGT was later reduced, it remains on and during landing, when the nose wheel touches the ground, the engine will be shut down automatically.

### RT-12-9 EGT Limiting System Controls and Indication

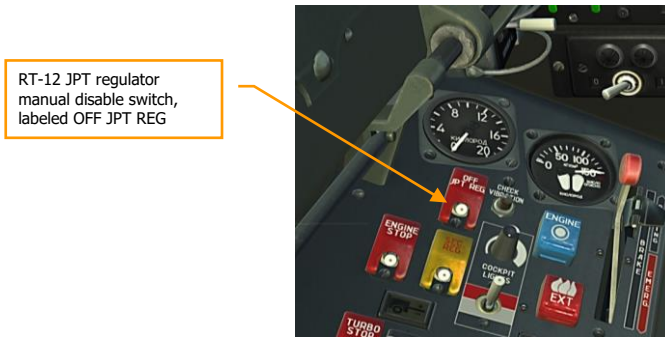

**Figure 75: RT-12 JPT regulator manual disable switch**

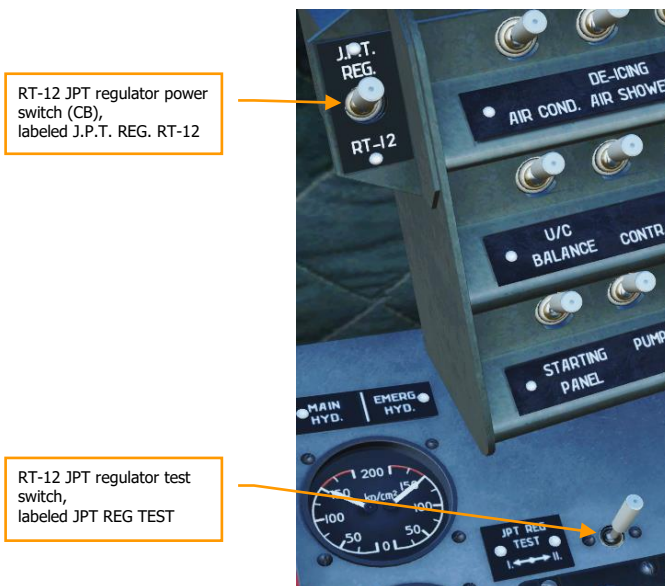

**Figure 76: RT-12 JPT regulator power and test switches**

The RT-12 JPT regulator manual disable switch (OFF JPT REG), installed on the left panel in the front cockpit, disables the engine overheat protection system.

The RT-12 JPT regulator power switch / circuit breaker (J.P.T. REG.), located on the auxiliary electric distribution panel in the front cockpit, enables power to the engine overheat protection circuit.

The spring-loaded RT-12 JPT regulator test switch (JPT REG TEST), located on the right panel in the front cockpit, is intended to check system functionality when the engine is not running. It is necessary to press and hold the switch in position I and check if the J.P.T. 700°C warning light is on, indicating normal system operation. Repeat the same for position II – the J.P.T. 730°C indicator will come on. It is not recommended to toggle this switch after engine start, because it enables the fuel limiting valve.

## Indicators

The J.P.T. 700°C warning light is installed on the caution & advisory lights panel in the front cockpit. It illuminates (continuously), when the EGT reaches 700 °C.

The J.P.T. 730°C warning light is installed on the caution & advisory lights panel in the front cockpit. It illuminates (flashes), when the EGT reaches 730 °C.

There are no J.P.T. 700°C and J.P.T. 730°C indicators in the rear cockpit.

## Engine Anti-Icing System

The engine anti-icing system is used to prevent engine parts, located at the engine inlet (turbine blades, air intake fairings), from icing. System controls and indication is similar to the anti-icing system of the airplane.

## Engine Startup System

The startup system is used to spin the engine rotor up from a standstill to RPM corresponding with the idle throttle setting during the engine startup procedure.

Units involved in startup:

- Startup automatics
- Engine fuel automatics
- Compressed air generator (source)
- Air starter

The Saphir-5 auxiliary power unit (APU) is used as a source of compressed air for engine startup. It provides compressed air and feeds the starter, which spins up the AI-25TL's high pressure rotor.

## Engine Controls in Front and Rear Cockpits

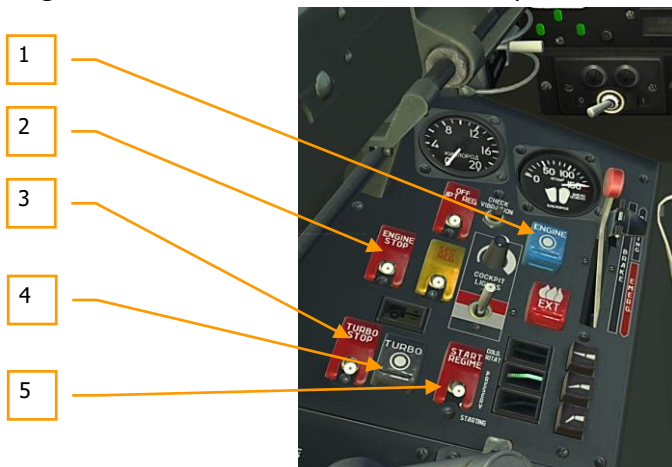

**Figure 77: Engine controls, front cockpit**

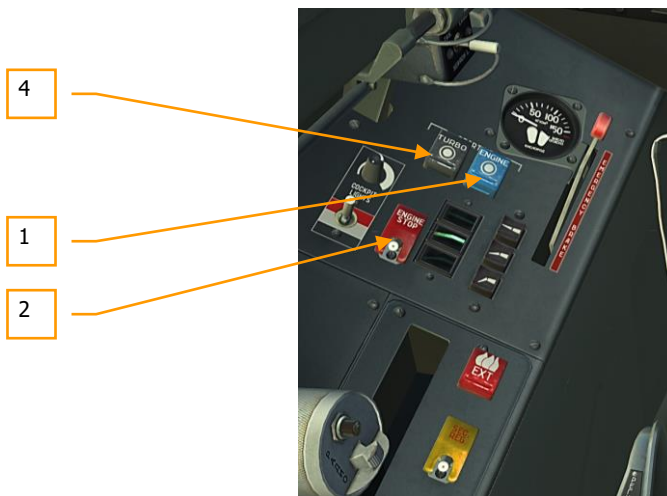

**Figure 78: Engine controls, rear cockpit**

1. ENGINE button for starting the AI-25TL engine
2. ENGINE STOP switch for emergency engine stop by electrical signal, regardless of throttle handle position.
3. TURBO STOP switch for disabling the Saphir-5 APU
4. TURBO button for starting the Saphir-5 APU. When the APU is running, the TURBINE STARTER lamp illuminates (continuously) on the caution & advisory lights panel in the front cockpit.
5. Engine Start Mode Switch (labeled START REGIME), must be in the STARTING position.

The throttle is located on the left panel in both cockpits, and is used to set the required engine operation mode. The throttle in the front cockpit has markings to show the selectable engine operation modes:

- STOP
- triangle mark (used when the engine has to be started using the emergency fuel system)
- IDLE
- CR SPEED (cruise speed)
- NOM (nominal mode)
- TAKE OFF.

The throttle in the front cockpit also has a STOP latch, used when shutting down the engine.

The throttle in the rear cockpit does not have operation mode markings and does not have a STOP latch, therefore the throttle can only be set to the STOP position from the front cockpit. The back cockpit throttle has an extendable lock, preventing accidentally setting the throttle to the STOP position in flight. To put the front throttle in the STOP position, the extendable lock in the rear cockpit has to

be opened (retracted). The engine can be shut down with the help of the **ENGINE STOP** switch or by closing the **Shut-off valve**.

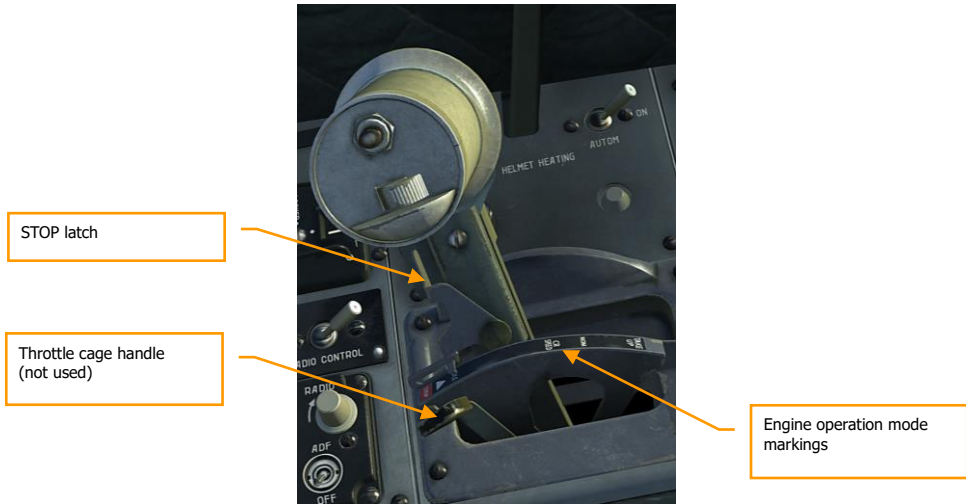

**Figure 79: Throttle, front cockpit**

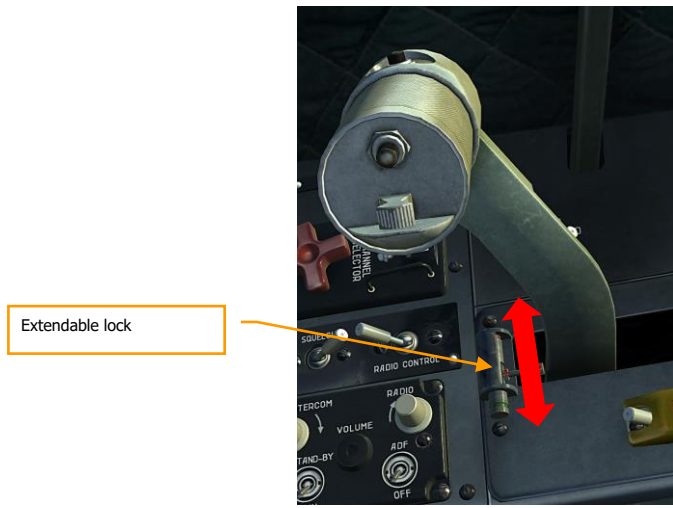

**Figure 80: Throttle, rear cockpit**

The AI-25 TL engine has the following operating modes:



- **Takeoff mode – “TAKE OFF”**. Corresponds to the maximum allowed high pressure compressor (HPC) RPM of 106.8% ( $n_1$  needle on the engine RPM gauge) and maximum thrust. This mode is used for takeoff, climbing and increasing the flight speed. EGT should not exceed 660 °C.
- **Nominal mode – “NOM”**. Corresponds to 103,2% of HPC RPM ( $n_1$  needle on the engine RPM gauge) and maximum thrust. This mode is used for long-term climbing for flight with near maximum speeds. EGT should not exceed 625 °C.
- **Cruise mode (85% of NOM power) – “CR SPEED”**. Corresponds to 99,6% HPC RPM ( $n_1$  needle on the engine RPM gauge). This mode is used for flight at maximum range (maximum duration of flight), because the fuel consumption is the lowest. EGT should not exceed 590 °C.
- **Idle mode – “IDLE”**. Corresponds to minimum allowed HPC RPM needed for stable engine operation and is equal to  $56 \pm 1,5\%$  ( $n_1$  needle on the engine RPM gauge). EGT should not exceed 600 °C.

Engine RPM is monitored using the ITE-2 tachometer and EGT using the TST-2 thermometer.

ITE-2 ( $n_1$  pointer – HPC RPM,  $n_2$  pointer – LPC RPM) and TST-2 are located in both cockpits.



**Figure 81: ITE-2 tachometer and TST-2 EGT thermometer gauges**

The TST-2 EGT indicator provides an indication of the EGT measured at the point where the combusted gases exit the turbine. The system consists of a temperature transmitter located on the engine turbine ring and two indicators, one in each cockpit. The temperature transmitter output signal can be connected to only one indicator at a time. The EGT indicator selector switch (labeled ENG IND), located on the left panel in the rear cockpit selects EGT indication to be displayed on either the front (switch in FWD position) or rear (switch in AFT position) indicator.



Figure 82: EGT indicator selector switch

## Engine Main Specification and Restrictions

Parameters	Operation mode			
	Takeoff	Nominal	Cruise	Idle
Thrust, kgF	1720	1500	1275	≤135
RPM, %	106,8	103,2	99,6	56±1,5
Maximum EGT, °C				
on ground	660	625	590	600
in flight	At H≤8000 m 685 (705*) At H>8000 m 715	650 670*	615 635*	600
Maximum fuel pressure, kgF/cm <sup>2</sup>	65	65	65	65
Oil temperature at engine inlet, °C	-5 to +90	-5 to +90	-5 to +90	-5 to +90
Maximum operational altitude, m	10.000	12.000	12.000	12.000
Maximum duration of continuous operation, min	20	Unlimited	Unlimited	On ground: 30 In flight: unlimited
Engine response time when throttle handle is moved from idle to max mode, s	9-12			
Engine startup time on ground and in flight, s	≤50			
Maximum allowed EGT during startup, °C				
on ground	550			
in flight	600			

\* when anti-icing system is enabled, EGT increases at 25-30°

# Aviation Equipment

The "aviation airplane equipment" (the Russian terminology is kept intentionally) is intended to provide electrical consumers with energy in the form of direct and alternate currents, control the power plant and monitor its operation, determine flight parameters and control various units and systems of the airplane.

## The aviation equipment of the L-39C includes:

- Electrical equipment
- Instruments (gauges)
- Oxygen equipment and special equipment for "high-altitude" flights
- Onboard monitors and flight data recording devices

## Electrical Equipment

### Direct Current Supply System

The Direct Current Supply System including:

- VG-7500JA primary DC generator;
- GSR-3000 backup DC generator;
- 12-SAM-28 onboard lead-acid battery (24 V / 28 Ah).

In case of primary generator failure, the standby generator takes over the current supply automatically. When both generators have malfunctioned, the emergency current source (battery) takes over the power supply.

Nominal operating voltages:

- VG-7500JA – 28 V;
- GSR-3000 – 28 V;
- 12-SAM-28 – 24 V.

The VG-7500JA is driven by the engine and the GSR-3000 is driven by the RAT.

The GSR-3000 ram air turbine (RAT) backup generator is extended into the air flow automatically if the VG-7500JA or engine malfunction during flight. It is necessary to maintain an airspeed of more than 280 km/h for the backup generator to start generating electricity for the onboard electrical consumers. The RAT can be extended in an emergency with the help of the emergency extension valve, located on the right panel in both cockpits. In case of a forced landing with a non-working engine and retracted gears, the RAT must be retracted before landing. Switch off the Emergency Generator Switch, labeled EMERG. GENERATOR. If the landing gear is emergency retracted, the RAT will be retracted as well.



**Figure 83: GSR-3000 ram air turbine**

The 12-SAM-28 battery is an emergency source of energy and provides power supply to important consumers in case of main and backup generator failure.

## Alternate Current Supply System

The Alternate Current (AC) Supply System includes the following:

- Two SPO-1000 inverters (1 and 2) – 115 V
- SPT-40 inverter – 36 V
- PT-500C inverter – 36 V

The SPO-1000 provides power supply to:

- RSBN-5S
- RV-5
- RKL-41
- MRP-56P
- R-832M
- Air conditioning system
- IV-300 engine vibration indicator
- RIO-3

The SPT-40 supplies:

- Backup artificial horizon electrical pointer
- Capacitive fuel meter
- Fuel and oil pressure gauges
- Longitudinal trim indicator

The PT-500C supplies:

- AGD-1 attitude director indicator (ADI)
- GMK-1AE gyro magnetic compass
- RSBN-5S

## Electrical Power Distribution

To distribute electrical energy, the front cockpit of the L-39C has two electrical distribution panels: the main CB panel and the auxiliary CB panel.

There is an electrical distribution panel in the rear cockpit as well. Circuit breakers on this panel are command ones, i.e. they override those of the front cockpit.

Main Electrical CB panel in the Front Cockpit



Figure 84: Main electrical CB panel, front cockpit

1. Battery switch – connects battery or ground supply to the power network

2. Main generator switch – connects the main generator to the power network
3. Emergency generator switch – connects the backup generator to the power network
4. Engine switch – enables engine startup, operation, monitoring of engine operation and enables the 3x36V inverter
5. AGD-GMK switch – enables the PT-500C inverter and supplies both GMK-1AE and AGD-1 with DC voltage
6. Inverter 1 switch – enables the first SPO-1000 AC 115V inverter
7. Inverter 2 switch – enables the second SPO-1000 AC 115V inverter
8. RDO (ICS and Radio) switch – enables the SPU-9 intercom and the R-832M radio
9. MRP-RV switch – enables the MRP-56P marker beacon receiver and the RV-5 radar altimeter
10. RSBN (ISKRA) switch – enables the RSBN-5S / ISKRA-K system
11. IFF (SRO) emergency connection switch – enables power to the IFF transponder in flight and on the ground using the battery in case of main and backup generator failure
12. RSBN (ISKRA) emergency connection switch – enables the RSBN-5S / ISKRA-K system powered by backup generator or battery in case of main generator failure
13. Wing tanks switch – enables the wingtip tank fuel consumption indication system
14. RIO-3 de-icing signal switch – enables the RIO-3 sensor
15. SDU switch – enables the SDU remote command landing system

Note:

The switches on the main electrical panel are "automatic circuit breakers" (ACBs) – in Russian "Автомат Защиты Сети" (АЗС) – and act as both switches and individual circuit breakers at once.

## Auxiliary Electrical CB Panel in the Front Cockpit

On the auxiliary electrical CB panel there are 24 circuit breakers, enabling various electrical consumers. In normal operation of the airplane, all CBs on the auxiliary panel are enabled by the ground crew before a flight and the pilot has to ensure that all of them are enabled.

In the DCS: L-39C module, all CBs on the auxiliary panel are enabled by default.



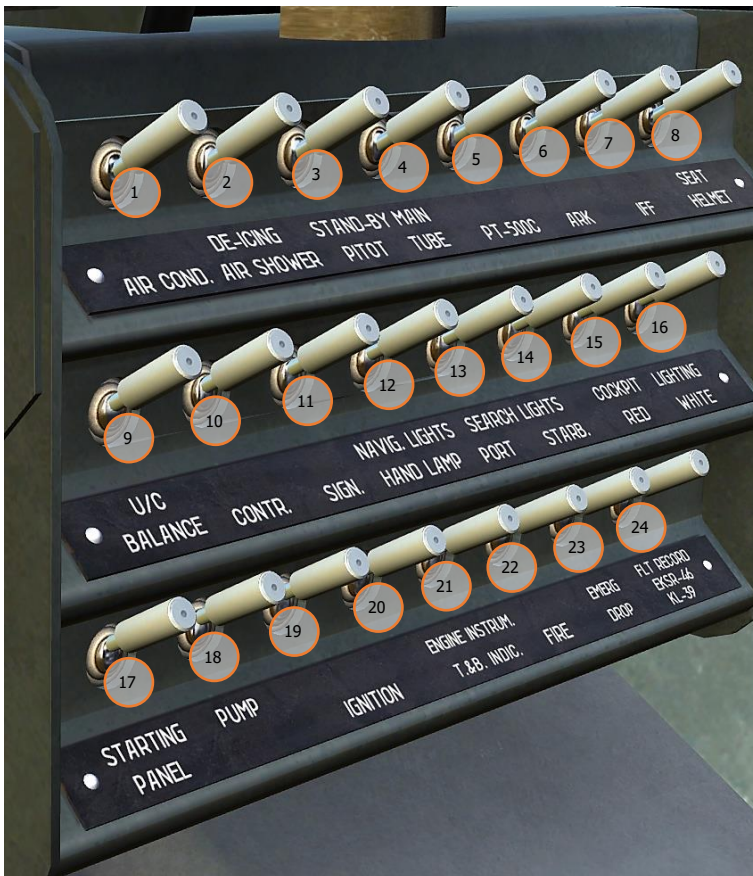

**Figure 85: Auxiliary electrical CB panel, front cockpit**

The auxiliary electrical CB panel contains the following circuit breakers:

1. AIR COND – supplies the air conditioning system
2. DEICING AIR SHOWER– supplies the anti-icing system. It supplies the ventilation suit and the pilot air shower valves as well, but this function is not implemented in the simulation.
3. STAND-BY PITOT TUBE – supplies the backup (left) pitot tube
4. MAIN PITOT TUBE – supplies the primary (right) pitot tube
5. PT-500C – enables the PT-500C inverter
6. ARK – enables the RKL-41 ADF
7. IFF – enables the SRO-2M transponder
8. SEAT HELMET – supplies the seat adjustment mechanism in the front cockpit (height adjustment) and the helmet visor heating circuit. Not implemented in the simulation.

9. U/C BALANCE – supplies the systems for control and indication of aileron and elevator trimmers, landing gear and flaps
10. CONTR. – supplies the flaps and air brakes control system, enables braking system control, indication of critical Mach number and supplies the speed blocking relay, which triggers at a speed of 310 km/h and enables the "STAND ALERT" (Ready) indicator, indicating readiness of the armament control system
11. SIGN. – supplies the indicator lamps on all indicator panels in the front cockpit
12. NAVIG. LIGHTS HAND LAMP – supplies the emergency floodlight lamp and exterior lighting system
13. SEARCH LIGHTS PORT – supplies the landing-taxi headlight control system
14. SEARCH LIGHTS STARB. – supplies the landing-taxi headlight control system
15. COCKPIT LIGHTING RED – supplies the red cockpit floodlight
16. COCKPIT LIGHTING WHITE – supplies the white cockpit floodlight
17. STARTING PANEL – supplies the engine starting panel
18. PUMP – supplies the engine fuel pump
19. IGNITION (Ignition) – supplies voltage to the CBs on the auxiliary panel, responsible for engine start, operation and monitoring
20. IGNITION (Ignition) – supplies voltage to the CBs on the auxiliary panel, responsible for engine start, operation and monitoring
21. ENGINE INSTRUM. T.&B. INDIC. – enables the SPT-40 inverter
22. FIRE – supplies the onboard fire extinguishing system
23. EMERG DROP – supplies the EMERG. JETTIS switch
24. FLT RECOR EKSR-46 KL-39 – supplies the EKSR-46 flare launcher, ejection system and SARPP-12GM flight data recorder

## Rear Cockpit Electrical CB Panel



**Figure 86: Rear cockpit electrical CB panel**

1. NETW switch – allows inclusion of any current source into the onboard network. Caution: Must always be enabled!
2. SEAT CB – supplies the rear cockpit seat adjustment mechanism (seat height adjustment)
3. SIGNAL CB – supplies indicator lamps on all indicator panels in the rear cockpit
4. ARMS CB – supplies the weapon control ACB in front cockpit. This CB is a command one, overriding that of front cockpit.
5. INTERCOM GROUND CB – used for communication with the ground crew.

## Connecting AC and DC Sources to the Power Network and Their Monitoring

### Connecting ground power into the onboard power network

Ground power connection is indicated to pilot in the cockpit by the illuminating indicator light with a ground equipment symbol (117) on the left panel in the front cockpit and by the voltmeter (voltage within 27-29 V). There is no voltmeter in the rear cockpit.



**Figure 87: External power indicator light**

### Connecting the 12-SAM-28 battery to the onboard power network

To connect the battery to the onboard power network, it is necessary to enable the BATTERY switch on the main electrical CB panel. Connection is controlled by a voltmeter and by GENERATOR MAIN and GENERATOR EMERG indicators, flashing on the emergency panel. Voltage on the voltmeter should read 24 V.

### Connecting the main generator to the onboard power network

To connect the main generator, it is necessary to enable the GENERATOR MAIN switch on the main electrical CB panel. The main generator will be connected to the power network after the engine is started and ground power is disconnected. When the main generator is connected, the GENERATOR MAIN and GENERATOR EMERG indicators go out. Voltage on the voltmeter should be within 28-29 V.

### Enabling the SPO-1000 inverters:

To enable the SPO-1000 inverters I and II, it is necessary to enable the [115V INVERTOR I](#) and [115V INVERTOR II \(96\)](#) CBs on the main electrical CB panel in the front cockpit.

Correct operation of the inverters is verified by checking the normal operation of the electrical consumers powered by the two inverters, as mentioned above.

Should one of the inverters fail, all consumers automatically switch to the working inverter and the INV. 115V FAIL indicator starts flashing on the warning lights panel in both cockpits.

### Enabling the SPT-40 inverter:

This inverter is enabled by the [ENGINE](#) CB on the main electrical CB panel in the front cockpit.

Correct operation of the inverter is verified by checking the normal operation of the electrical consumers powered by this inverter, as mentioned above.

In case of inverter failure, the red INV. 3x36V FAIL indicator illuminates on the caution & advisory lights panel in both cockpits. This lamp operates in flashing mode.

### Enabling the PT-500C inverter:

This inverter is enabled by the [AGD-GMK](#) CB on the main electrical CB panel in the front cockpit.

Correct operation of the inverter is verified by checking the normal operation of the electrical consumers powered by this inverter, as mentioned above.

# Lighting System

The lighting system of the L-39C is divided into the following subsystems:

- Exterior lighting
- Interior lighting
- Cockpit indications, including warning, caution and advisory indicator lights

## Exterior Lighting

This exterior lighting subsystem is used to mark the airplane on the ground and in the air and consists of the following lights:

1. Three navigation (position) lights: two lights of green and red color, located on the right and left tip tanks respectively, and a white light, installed on the top of the fin. Because these lights indicate the relative position of the aircraft, they are also called "position lights".
2. Two landing/taxi lights: one combined landing/taxi light with two filaments is mounted to the tip of each wingtip tank. The difference between landing and taxi lights is the width of the light beam. Taxi lights have a wide beam, because they illuminate the runway / taxiway while moving on the ground during darkness and provide illumination just in front of the nose. Landing lights have a narrower beam, because they are used to illuminate the terrain and runway ahead during takeoff and landing from greater distances. and the beam of the landing light filament covers a larger (all-round) pattern.
3. Three white landing gear down indicating lights installed on each landing gear leg: one nose gear down light and two main (left & right) gear down lights. These lights act as downlock indicators, i.e. the lights come on when the respective gear is down and locked.

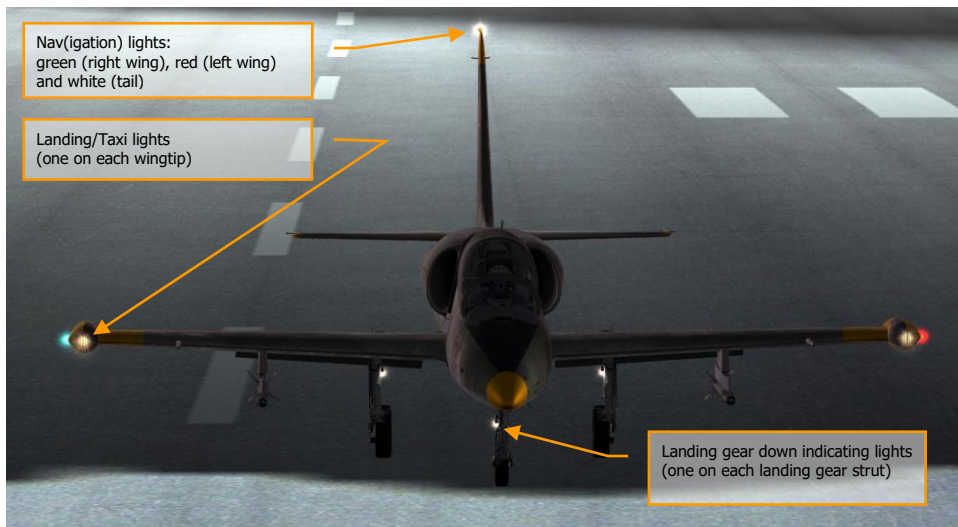

**Figure 88: Exterior lights**

## Exterior lighting controls

The controls for the exterior lighting are located on the right console auxiliary switch panel in the forward cockpit only:

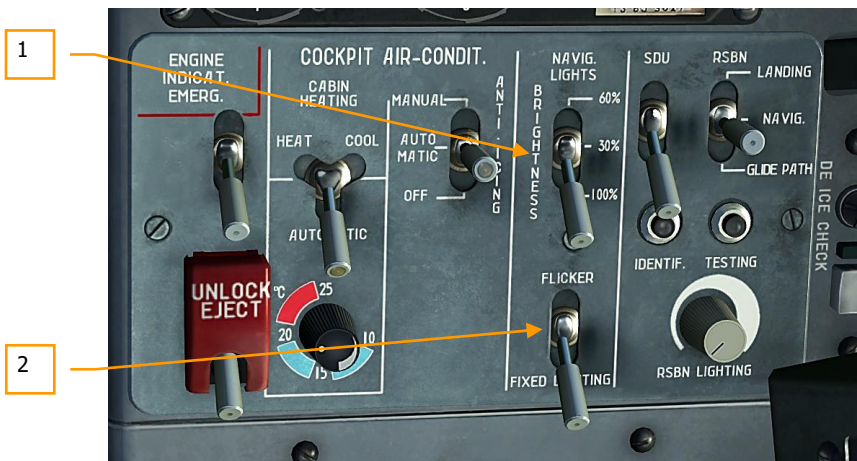

**Figure 89: Controls for navigation lights**

The navigation lights are controlled by the following two three-position switches in the NAVIG. LIGHTS section of the panel:

1. Navigation lights intensity control switch (labeled BRIGHTNESS) with three different brightness settings (from top to bottom):
  - a. 60% (BRT): medium brightness
  - b. 30% (DIM): minimum brightness
  - c. 100% (MAX): maximum brightness

This switch setting is effective only when the navigation lights mode control switch (see below) is not in OFF (middle) position.

2. Navigation lights mode control switch with three different settings (from top to bottom):
  - a. FLICKER: navigation lights are flashing
  - b. OFF: navigation lights are turned off
  - c. FIXED LIGHTING: steady illumination of the navigation lights





**Figure 90: Taxi and landing lights control switch**

The three-position taxi and landing lights control switch (labeled SEARCH L.) is used for enabling various light modes and disabling the lights. The switch is located in both cockpits above the forward part of the left console and has the following positions (from left to right):

- TAX. (TAXIING): taxi lights go off automatically when the landing gear is retracted
- OFF: taxi and landing lights are switched off
- LAND. (LANDING): landing lights remain on regardless of landing gear position

When flying at night, the pilot can use the landing lights to verify extension of the landing gear. To do that, it is necessary to set the taxi and landing lights control switch in the TAX. position. If the lights illuminate, the gear is extended (down) – if they don't illuminate, the gear is retracted (up).

Note. Using the landing lights on the ground or during taxi is not recommended longer than 3 seconds due to lamp overheat (not simulated).

The landing gear down lights are automatically switched on when the gear is extended, provided that the navigation lights mode control switch is not in OFF (middle) position.

## Interior Lighting

### Cockpit Lighting System with Red and White Floodlights

The interior lighting system of the aircraft is intended to illuminate gauges and panels with red (main) and white (auxiliary / backup) colors. It consists of two separate circuits for each cockpit, main and auxiliary. The main circuit illuminates in red and the auxiliary circuit illuminates in white.

When the main (red lighting) circuit fails and its circuit breaker pops out, the auxiliary (white lighting) circuit is automatically turned on. It is also possible to switch on the auxiliary circuit manually.

The cockpits consist of the following lighting components:

- Forward cockpit

- Individual instrument lights
- Six console light bulbs
- One center pedestal light
- Standby compass light
- Pitch trim position indicator light
- Directional gyro control box
- Aft cockpit
  - Individual instrument lights
  - Four console lights
  - One center pedestal light

In both cockpits, each instrument on the instrument panel is equipped with red or white bulbs for indirect illumination. The instrument lights are controlled from the COCKPIT LIGHTS section on the left panel.

The KI-13 magnetic compass is always illuminated by white color, regardless of the position of the instrument lighting switch.

**When both red and white lighting systems fail, emergency interior lighting must be enabled, which exists in the front cockpit only!**



**Figure 91: Interior lighting system controls, front and rear cockpits**

In both cockpits, the left panel contains a COCKPIT LIGHTS section with the following two controls (from top to bottom):

1. Instrument light intensity knob. Rheostat for regulating the brightness of the instrument lights. Turning the rheostat clockwise (CW) increases the intensity, turning it counter-clockwise (CCW) decreases the intensity.
2. Instrument lighting switch. Three-position switch with the following positions:
  - a. Up: Main. Primary red lights activated.
  - b. Center: OFF. Both red and white lights deactivated.
  - c. Down: Auxiliary. Secondary white lights activated.



**Figure 92: White and red floodlight, front cockpit**

### Emergency Interior Lighting

The white instrument panel emergency light, located on the left side of the gunsight, provides illumination of the front cockpit instrument panel in emergency situations. There is no emergency light in the rear cockpit.

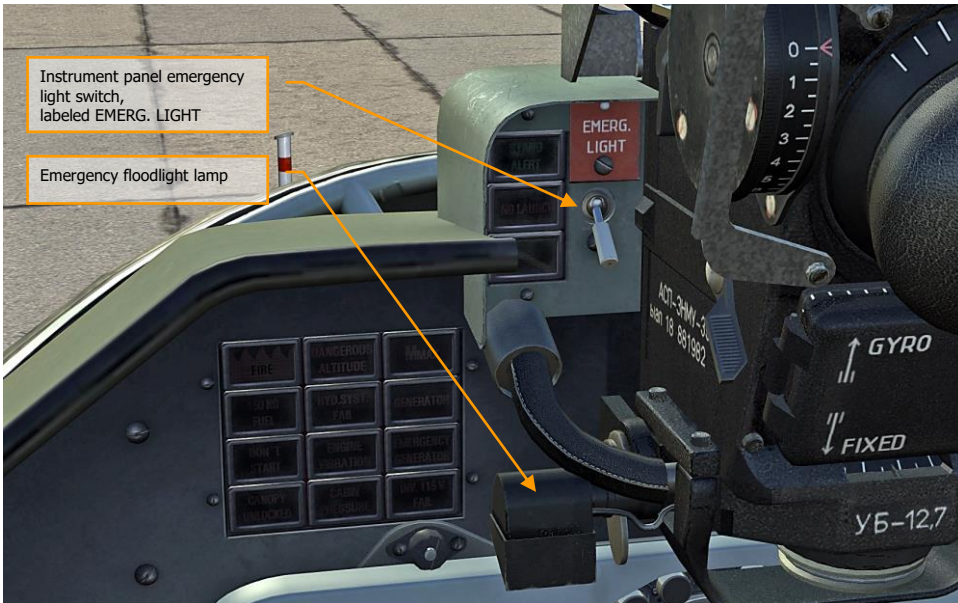

Figure 93: Instrument panel emergency light



Figure 94: Cockpit with activated instrument panel emergency light

## Cockpit Indications

This purpose of this subsystem is to inform the pilot about normal and abnormal (dangerous conditions or emergencies) operation of systems including the engine.

The system consists of:

- Information and warning light panels
- Landing gear position indication system (described in detail in the utility hydraulic system chapter: Landing Gear Position Indicator)
- Flap position indicators (described in detail in the utility hydraulic system chapter)
- Neutral trimmer position indication panel (described in detail in the airplane control system chapter)
- Ground power connection indicator
- Armament status panel (described in detail in the combat deployment chapter)

Information and emergency panels are installed on the left and right sides of the instrument panels in both cockpits.

### Warning Lights and Caution & Advisory Lights Panels

Each cockpit is equipped with an independent warning, caution and advisory light system which is located under the glare shield. The rectangular-shaped lights have white, red, yellow and green colors and bear either an inscription or a symbol. Warning lights are red, caution lights are yellow and advisory lights are either green or white. The warning lights flash.

The warning lights panels, installed in both cockpits, are identical and consist of 12 indicator lights.

The caution & advisory lights panels, installed in both cockpits, are different: In the front cockpit, the panel contains 16 lights, 15 of which are used, the 16th is reserved (not used). In the rear cockpit, the panel contains 12 lights, 11 of which are used, the 12th is reserved (not used). The caution & advisory lights panel in the rear cockpit has the following differences:

- INV. 3x36V FAIL instead of AIRCONDIT. EMERG.
- AZIMUTH CORRECT instead of CONFORM AZIMUTH
- DISTANCE CORRECT instead of TURBINE STARTING
- The following signals are absent:
  - ENG. MIN. OIL PRESS
  - J.P.T. 730°C
  - J.P.T. 700°C

The flashing red master caution light has no label and is located over the instrument panel in both cockpits. In the front cockpit, it is to the right of the ASP-3NMU gunsight. The master caution light flashes when one of the following indicator lights illuminates:

- FIRE
- 150 KG FUEL
- DON'T START
- CANOPY UNLOCKED

- HYD. SYST. FAIL
- ENGINE VIBRATION
- GENERATOR
- FUEL FILTER

These indicators are described in the corresponding chapters of this manual.

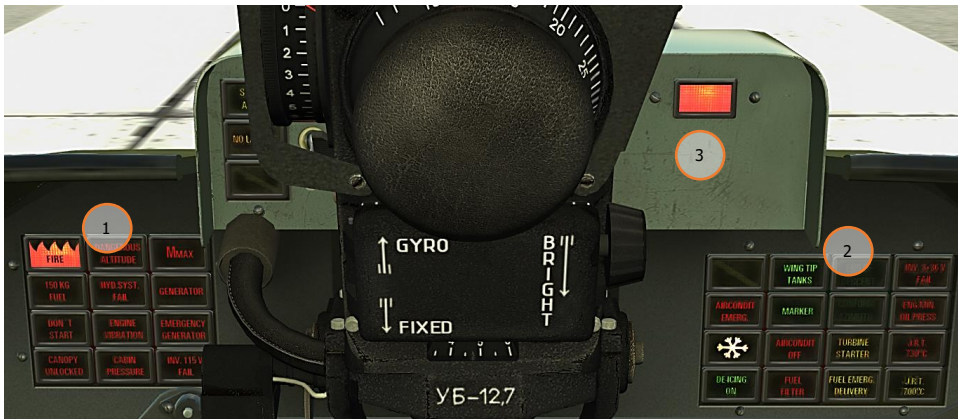

**Figure 95: Warning lights and caution & advisory lights panels, front cockpit**



**Figure 96: Warning lights and caution & advisory lights panels, rear cockpit**

1. Warning lights panel
2. Caution & advisory lights panel
3. Master caution light

The warning, caution and advisory light intensity control panel, installed on the right console in both cockpits, contains the following two controls:

1. Warning light intensity knob. This dimming rheostat allows adjusting the brightness of the following items in five stages:
  - a. Master caution light
  - b. All warning, caution and advisory lights
  - c. Landing gear position indicator panel
  - d. Flap position indicator panel
  - e. Trim indicators
  - f. Armament indicator lights

Dimming of the FDR ON light is achieved by rotating the lamp cap.

2. Warning light check button. When this test button is pressed, all warning, caution and advisory lights, except FDR ON, will illuminate as long as the button is held depressed.

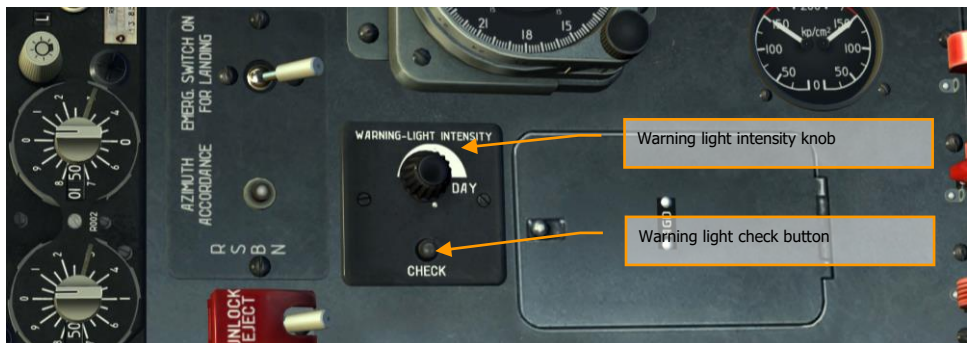

**Figure 97: Warning light controls, rear cockpit**

# СОСКИТ I-39C



↑ ГИРО

||| ВАЛТШ

||| НЕПОД

УБ-12,7



# COCKPIT L-39C

## Front Cockpit



Figure 98: Front cockpit

# Central Panel

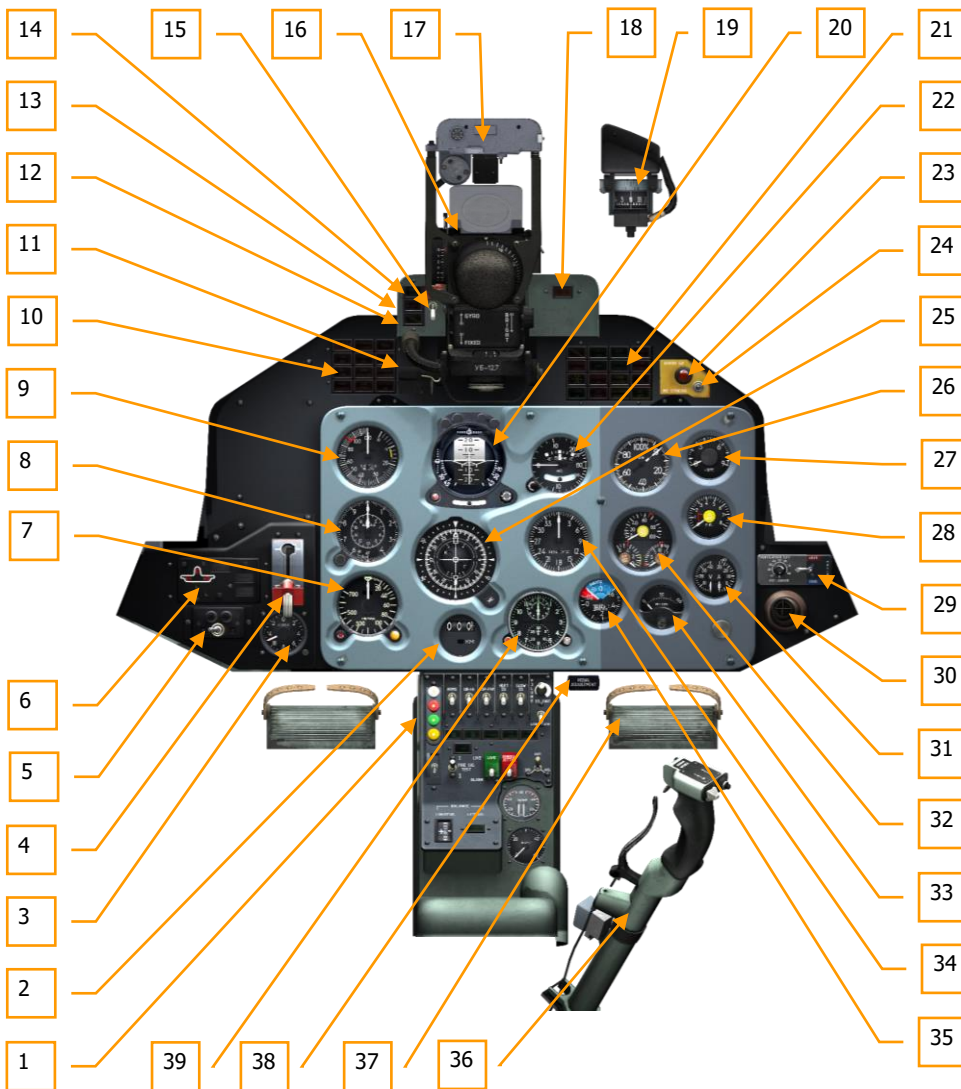
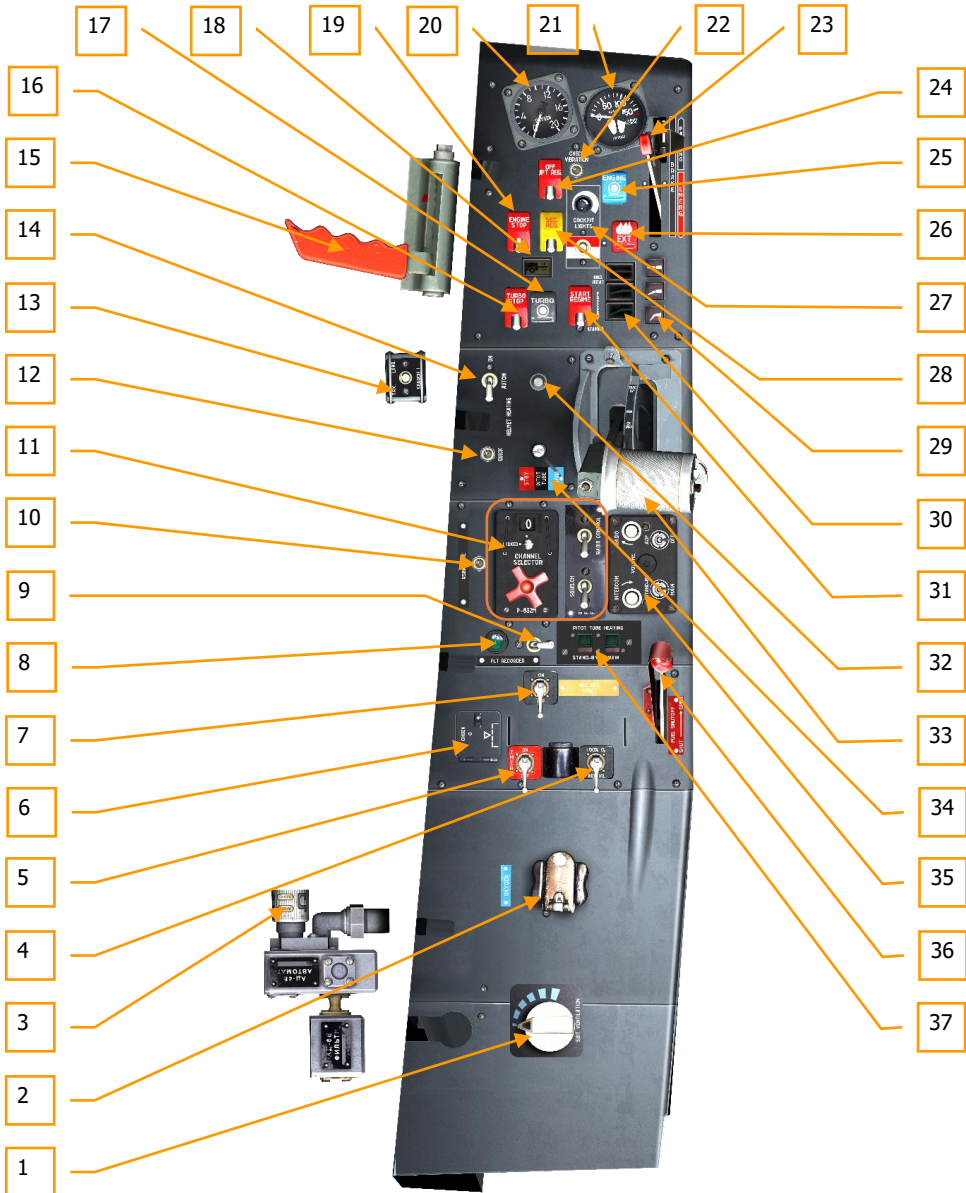

Figure 99: Front cockpit, central panel

1. EKSR-46 signal flare dispenser control panel
2. PPD-2 RSBN range indicator
3. Accelerometer
4. L/G control lever
5. RKL-41 ADF outer-inner beacon (far-near NDB) switch
6. L/G position indicator panel
7. RV-5M radar altimeter gauge
8. VD-20 barometric altimeter gauge
9. KUSM-1200 airspeed and Mach number indicator
10. Warning lights panel
11. Emergency floodlight lamp
12. Reserved indicator (not used)
13. "NO LAUNCH" indicator
14. "STAND ALERT" indicator
15. Instrument panel emergency light switch
16. ASP-3NMU gunsight
17. FKP-2-2 gun camera
18. Master caution panel
19. KI-13 magnetic standby compass
20. KPP-1273K gauge for AGD-1 attitude directional indicator (ADI)
21. Caution & advisory lights panel
22. Vertical velocity/turn & slip indicator
23. ERROR GA gyroscope error warning light
24. MC. SYNCHR magnetic heading alignment button
25. Radio magnetic indicator (RMI)
26. ITE-2 engine RPM gauge
27. TST-2 exhaust gas temperature (EGT) gauge
28. Fuel meter gauge
29. Diffuser and flight suit temperature control panel with control switch and desired temperature rheostat
30. Individual air shower duct (not used)
31. Voltammeter
32. Three-pointer oil and fuel pressure and oil temperature indicator
33. IV-200 engine vibration gauge
34. RKL-41 automatic direction finder (ADF) gauge
35. UVPD cockpit altitude and pressure difference gauge
36. Airplane control stick
37. Rudder pedal
38. Rudder pedal adjustment (based on pilot height, not used)
39. AChS-1M cockpit clock

# Left Panel



**Figure 100: Front cockpit, left panel**

1. Flight suit ventilation controller (not used)
2. Oxygen supply valve
3. AD-6E pressure regulator – for regulating air pressure in the anti-G suit’s inflatable bladders (not used)
4. Diluter demand switch – for switching between NORMAL demand (RPK-52 oxygen regulator mixture) and 100% O<sub>2</sub>
5. Emergency oxygen switch
6. Oxygen regulator test access
7. Helmet ventilation switch (not used)
8. Flight data recorder (FDR) light
9. Flight data recorder (FDR) switch
10. RSBN beacon audio button
11. R-832M radio control panel
12. Helmet visor quick heating button (not used)
13. Taxi/Landing lights control switch
14. Helmet visor heating switch (not used)
15. Canopy lock handle
16. TURBO STOP switch
17. TURBO button
18. External power indicator light
19. ENGINE STOP switch
20. Helmet oxygen pressure indicator (not used)
21. IK-52 oxygen pressure indicator and flow annunciator
22. IV-300 engine vibration meter test button
23. Emergency/Parking brake handle
24. RT-12 JPT regulator manual disable switch
25. ENGINE button
26. Fire extinguisher button
27. Cockpit floodlight control panel with red to white illumination color switch and brightness knob
28. SEC. REG. emergency fuel switch
29. Flap control buttons
30. Flap position indicators
31. Engine start mode switch
32. Helmet visor heating temperature controller (not used)
33. Throttle handle
34. Pitot tube selector lever – for switching between main and backup pitot tubes
35. SPU-9 intercom (ICS) control panel
36. Fuel shut-off valve lever
37. Pitot tube heating buttons

# Right Panel

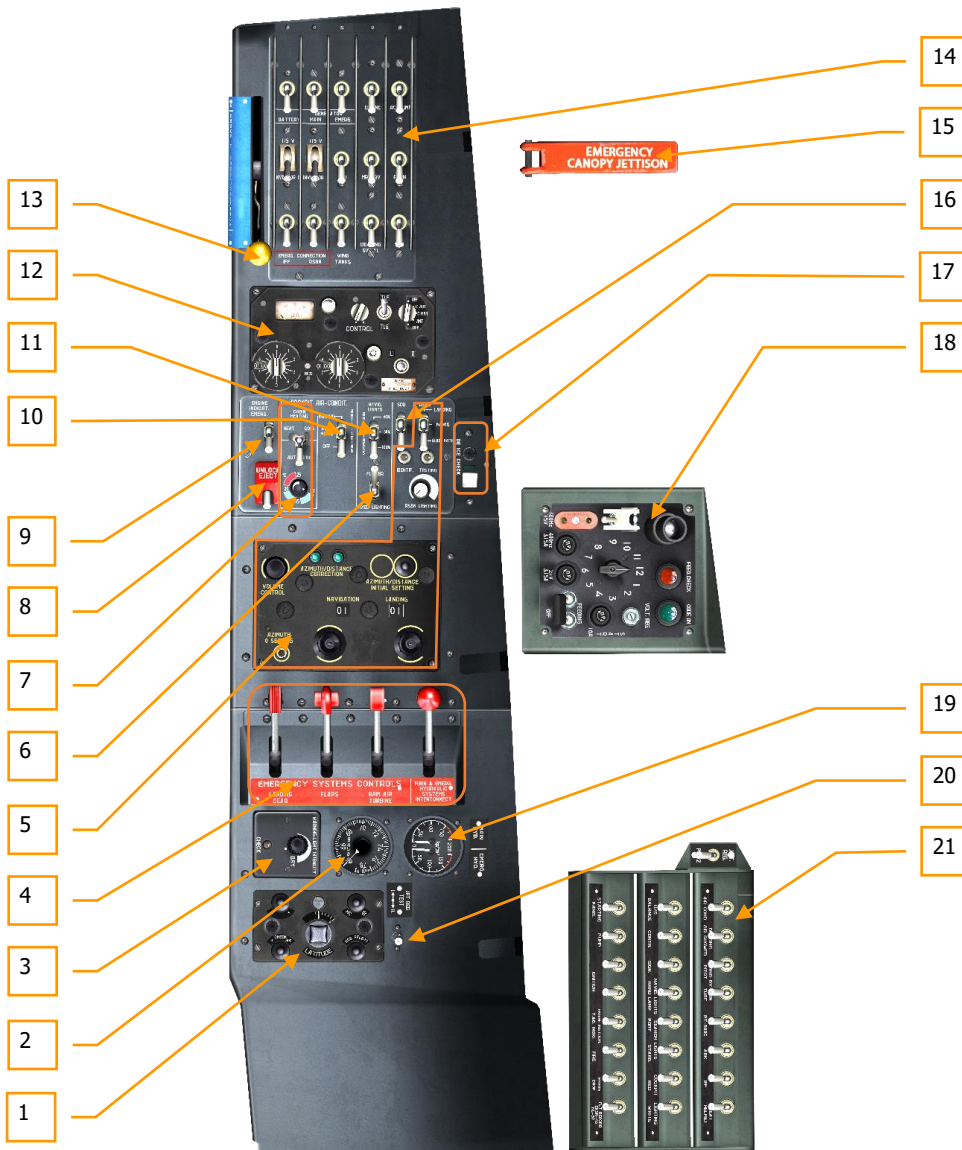

**Figure 101: Front cockpit, right panel**

1. PU-26E control panel for GMK-1AE directional gyro
2. ZDV-30
3. Warning light intensity knob and check button
4. Emergency extension and interconnection control levers (emergency hydraulic system valves)
5. RSBN-5S control panel
6. Navigation lights mode control switch
7. Cockpit temperature control panel with cabin air conditioning control switch and cabin air temperature controller
8. Ejection unlock switch (not used)
9. Emergency engine instruments power switch
10. De-icing mode switch
11. Navigation lights intensity (brightness) control switch
12. RKL-41 automatic direction finder (ADF) control panel
13. Cockpit pressurization and ECS handle
14. Main CB panel
15. Emergency canopy jettison handle
16. SDU remote command landing system switch
17. RIO-3 de-icing sensor heating circuit check button (ground check) and warning light
18. SRO (IFF) transponder control panel (not used)
19. Double-pointer main and emergency hydraulic systems pressure gauge
20. RT-12 JPT regulator (EGT limiter) test switch
21. Auxiliary CB panel

## Rear Cockpit



Figure 102: Rear cockpit



# Central Panel

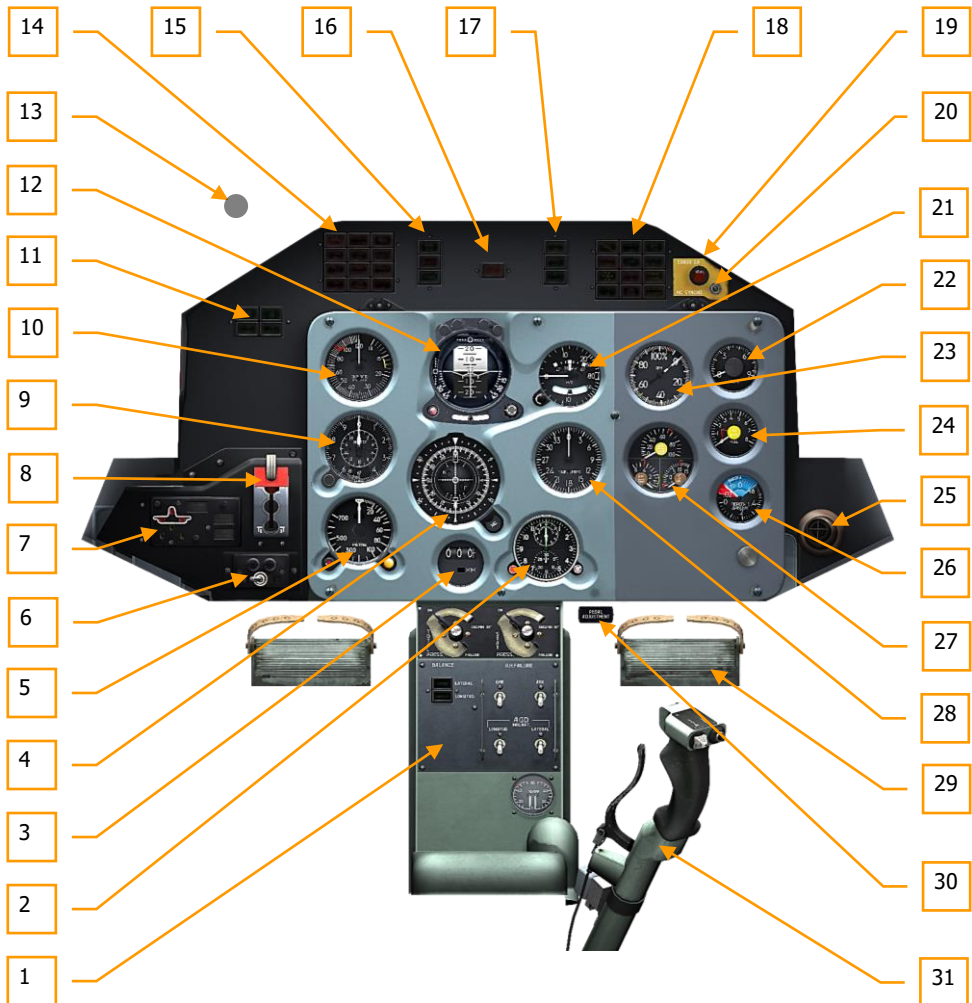

**Figure 103: Rear cockpit, front panel**

1. Pitch and roll trim indicator panel (on the left), fault simulation panel (on the right)
2. AChS-1M cockpit clock
3. PPD-2 RSBN range indicator
4. Radio magnetic indicator (RMI)
5. RV-5M radar altimeter gauge

6. RKL-41 ADF outer-inner beacon (far-near NDB) switch
7. L/G position indicator panel
8. L/G control lever
9. VD-20 barometric altimeter gauge
10. KUSM-1200 airspeed and Mach number indicator
11. Stores indication panel
12. KPP-1273K gauge for AGD-1 Attitude directional indicator (ADI)
13. IFR hood control handle
14. Warning lights panel
15. Left armament indication panel
16. Master caution panel
17. Right armament indication panel
18. Caution & advisory lights panel
19. ERROR GA gyroscope error warning light
20. MC. SYNCHR magnetic heading alignment button
21. Vertical velocity/turn & slip indicator
22. TST-2 exhaust gas temperature (EGT) gauge
23. ITE-2 engine RPM gauge
24. Fuel meter gauge
25. Individual air shower duct (not used)
26. UVPD cockpit altitude and pressure difference gauge
27. Three-pointer oil and fuel pressure and oil temperature indicator
28. RKL-41 automatic direction finder (ADF) gauge
29. Rudder pedal
30. Rudder pedal adjustment (based on pilot height, not used)
31. Airplane control stick

# Left Panel

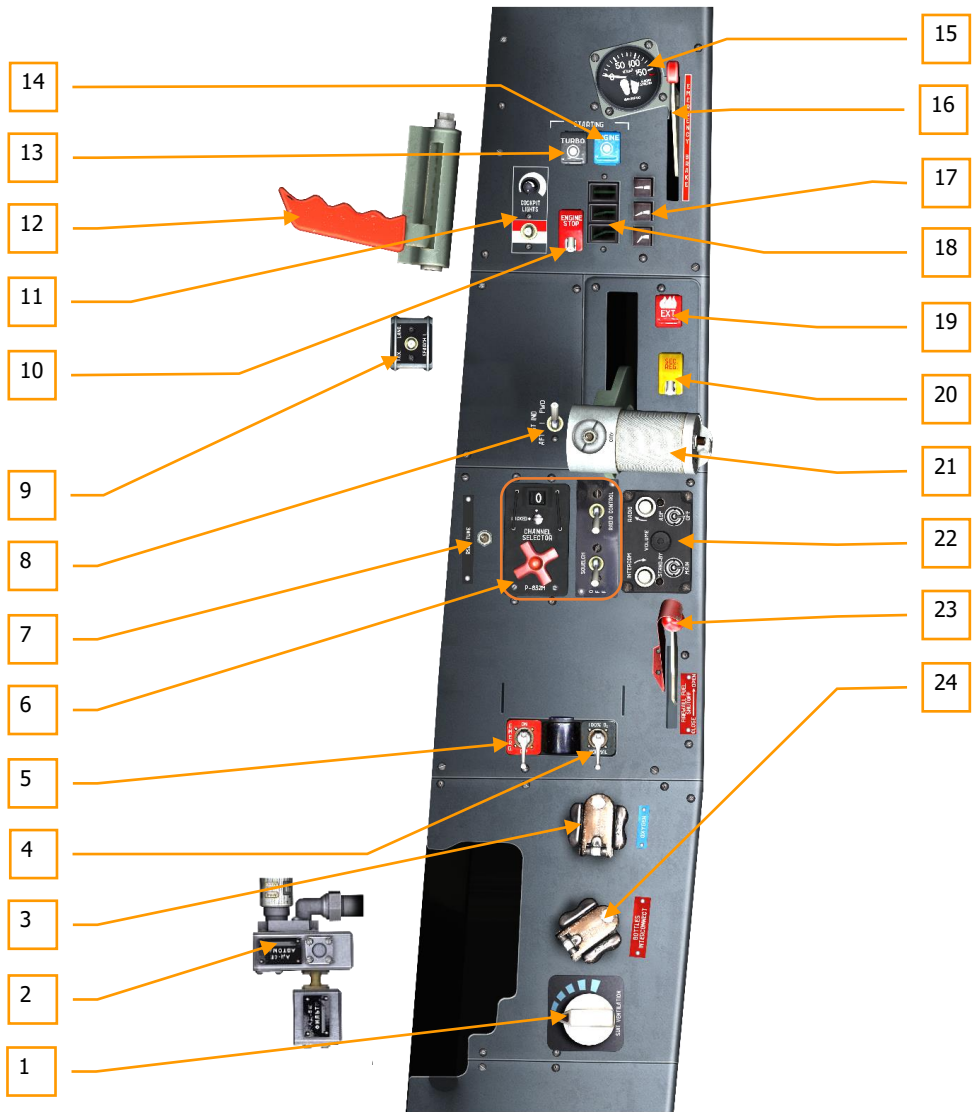

Figure 104: Rear cockpit, left panel

1. Flight suit ventilation controller (not used)
2. AD-6E pressure regulator (not used)
3. Oxygen supply valve
4. Diluter demand switch – for switching between NORMAL demand (RPK-52 oxygen regulator mixture) and 100% O<sub>2</sub>
5. Emergency oxygen switch
6. R-832M radio control panel
7. RSBN beacon audio button
8. EGT indicator selector switch – for switching between AFT and FWD cockpit EGT indication
9. Taxi/Landing lights control switch
10. ENGINE STOP switch
11. Cockpit floodlight control panel with red to white illumination color switch and brightness knob
12. Canopy lock handle
13. TURBO button
14. ENGINE button
15. IK-52 oxygen pressure indicator and flow annunciator
16. Emergency braking handle
17. Flap control buttons
18. Flap position indicators
19. Fire extinguisher button
20. SEC. REG. emergency fuel switch
21. Throttle handle
22. SPU-9 intercom (ICS) control panel
23. Fuel shut-off valve lever
24. Oxygen bottles interconnect valve

# Right Panel

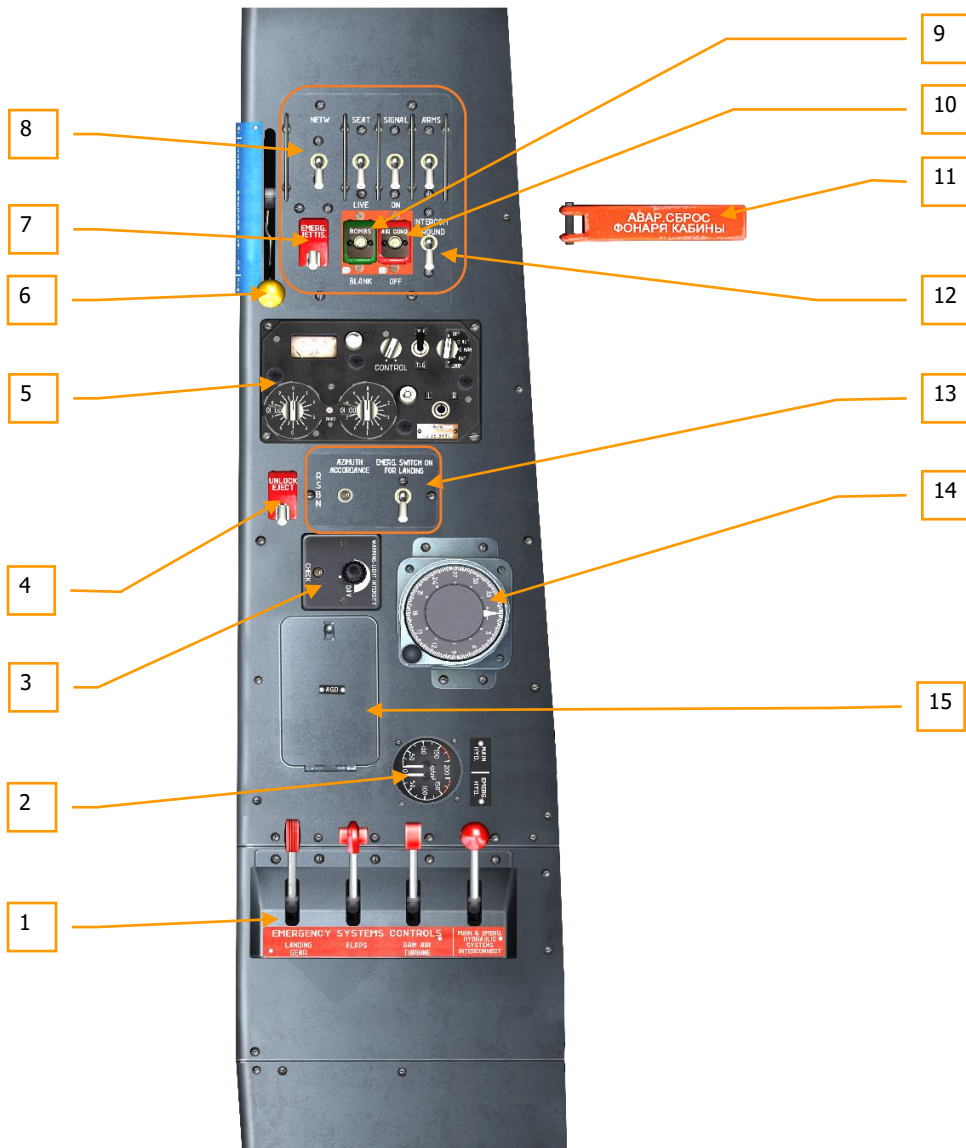

Figure 105: Rear cockpit, right panel

1. Emergency extension and interconnection control levers (emergency hydraulic system valves)
2. Double-pointer main and emergency hydraulic systems pressure gauge
3. Warning light intensity knob and check button
4. Ejection unlock switch (not used)
5. RKL-41 automatic direction finder (ADF) control panel
6. Cockpit pressurization and ECS handle
7. Emergency stores jettison switch
8. Miscellaneous CB panel
9. Arm/Safe bombs emergency jettison switch
10. Air conditioning emergency shut-off switch
11. Emergency canopy jettison handle
12. INTERCOM GROUND CB
13. RSBN-5S control panel
14. KM-8 correction mechanism
15. Gyro unit ground checkout access panel

# Instruments

## Flight and Navigation Instruments

Flight and navigation instruments provide the pilot with information about altitude, airspeed, angular position of the airplane, presence of angular velocity and skidding, G-value and time of flight.

Altitude and airspeed measurements are performed by aerometric devices, connected to the airplane air pressure system.

Measurement of the angular position in space and angular velocity is performed by gyroscopic instruments.

G-force is measured by the accelerometer and time by the cockpit clock.

A pitot-static system for measuring total and static pressure and transferring the measured pressure values to its consumers is installed on the airplane. The system consists of primary and backup pitot-static tubes. The primary pitot-static tube is installed on the right surface and the backup pitot-static tube on the left one. Pitot tube controls are located on the left panel in the front cockpit.

## Pitot-static system

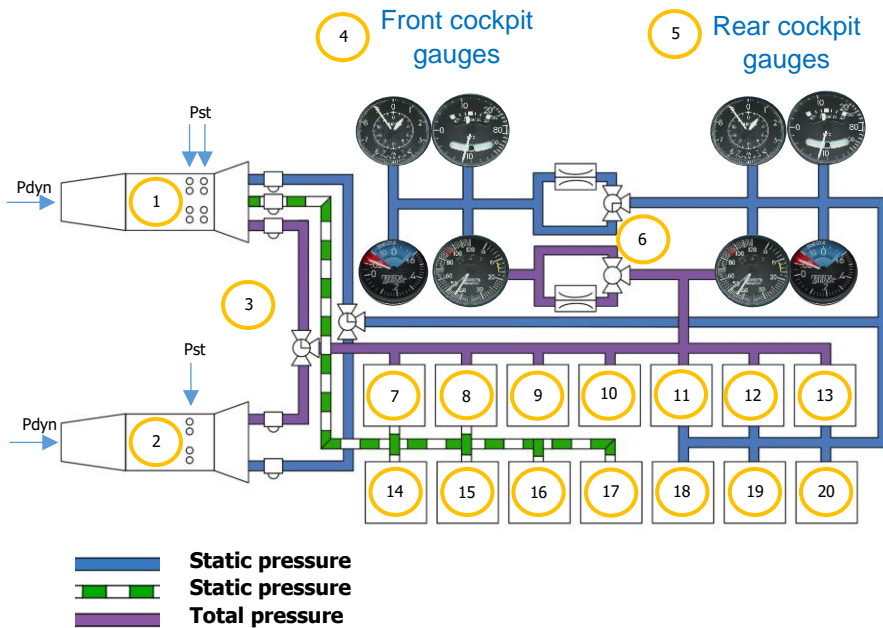

Figure 106: Pitot-static system

1. Primary pitot-static tube
2. Backup pitot-static tube
3. Primary/Backup pitot tube selector valve
4. Front cockpit gauges
5. Rear cockpit gauges
6. Pitot fault simulator valves
7. ISKRA-K unit airspeed sensor
8. ISKRA-K unit airspeed sensor
9. Front cockpit ejection seat speed pressure indicators
10. Rear cockpit ejection seat speed pressure indicators
11. SARPP-12GM FDR unit airspeed sensor
12. SARPP-12GM FDR speed and automatic activation sensor
13. Speed signalization in flap control sensor circuit
14. Cockpit pressure regulators
15. ASP-3NMU "altitude mechanism"



16. Cockpit pressure regulators
17. ISKRA-K unit pressure sensor
18. SARPP-12GM FDR unit altitude sensor
19. Radar altimeter sensor
20. Dangerous cockpit pressure alarm sensor

## Pitot-Static System Controls

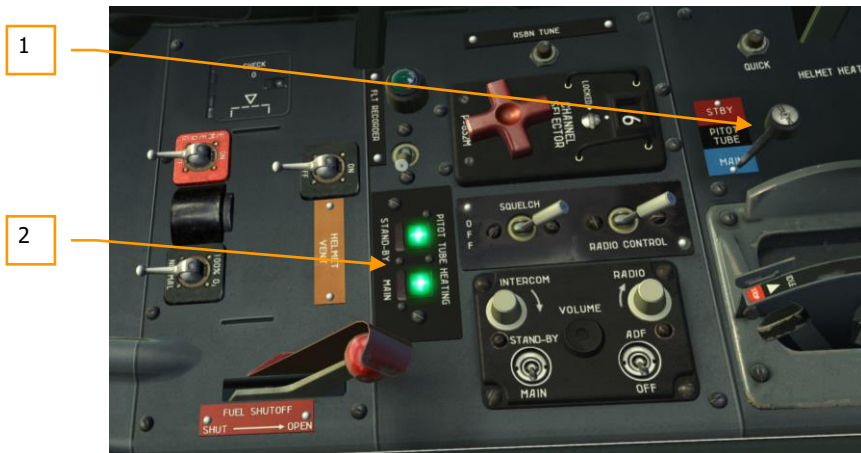

**Figure 107: Pitot-static system controls**

1. Pitot tube selector lever, for switching between backup (STBY, left) and primary (MAIN, right) pitot-static tubes.
2. Pitot tube heating buttons, for electrical heating of the pitot tubes. Left buttons turn on/off heating of the standby (left) pitot tube, right buttons control heating of the main (right) pitot tube.

To simulate failure in the front cockpit static and total pressure pitot system lines, two [pitot fault simulator selectors](#) are installed on the central pedestal in the rear cockpit. When the [total pressure pitot fault simulator selector](#) is set to the **FAILURE** position, a failure of the front cockpit KUSM-1200 airspeed and Mach number indicator is simulated. When the [static pressure pitot fault simulator selector](#) is set to the **FAILURE** position, failure of the VD-20 barometric altimeter gauge, variometer and UVPD cockpit pressure difference gauge is simulated in the front cockpit.

**Important: Pressure guards are installed to avoid damage to the pressure gauges in the front cockpit when switching from FAILURE to the ON position. To enable the pressure gauges in the front cockpit, it is necessary to first set the selectors from FAILURE to RED. MIN 30" and then, after 30 seconds, to the ON position.**

## Front Cockpit Gauge Fault Simulation Control



**Figure 108: Front cockpit gauge fault simulation panel**

1. Total pressure pitot fault simulator selector
2. Static pressure pitot fault simulator selector

## Aerometric Instruments

- VD-20 barometric altimeter;
- UVPD cockpit altitude and pressure difference gauge;
- KUSM-1200 combined airspeed and Mach number gauge;
- Combined gauge variometer (artificial horizon backup).

### VD-20 Barometric Altimeter

The altimeter located on the instrument panel in each cockpit, indicates aircraft altitude in meters.

The two pointer altimeter has two concentrically mounted pointers coded in length and shape. The short thick inner pointer indicates the altitude from 0 to 20,000 meters in 1,000 meters increments and the long outer pointer indicates increments of 100 meters and pans of hundreds. The smallest graduation is 10-meter increments.

The knob located in the left lower part of the instrument provides a barometric pressure setting from 670 to 790 mm of mercury column.



**Figure 109: VD-20 barometric altimeter**

1. Hundreds meters dial (measuring range – 0—1000 M, increments of 100 meters)
2. Thousands meters dial (measuring range – 0—20000 M, increments of 1000 meters)
3. Barometric pressure window
4. Barometric pressure / QFE adjustment knob, for setting the altitude pointers to “0”

5. Pressure correction indexes, for landing at high altitude airfields, where pressure is less than 670 mmHg. The indexes are moved by the knob.

### UVPD Cockpit Altitude and Pressure Difference Gauge

The "UVPD" is used to measure "altitude" in the cockpit as well as the pressure difference between cockpit and ambient atmosphere. The gauge combines both an altimeter ("cockpit altitude") and a pressure difference gauge in one case. It is installed on both instrument panels in the front and rear cockpits.

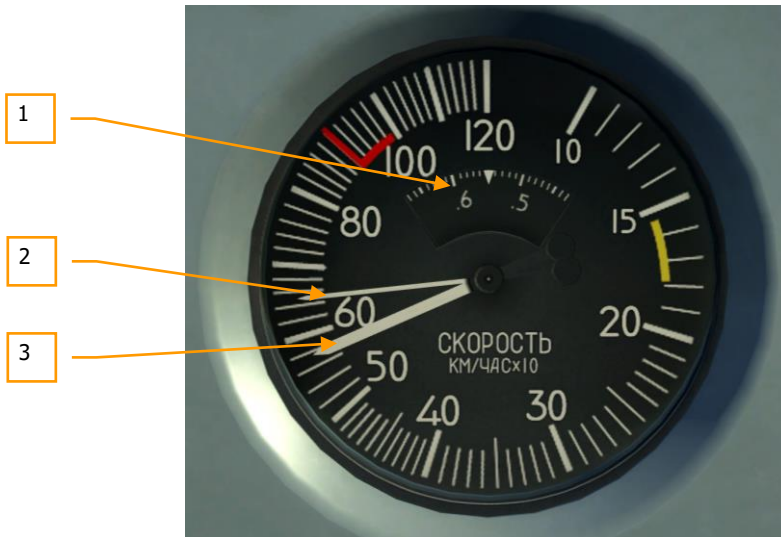

**Figure 110: UVPD cockpit altitude and pressure difference gauge**

1. Cockpit altitude scale
2. Pressure difference scale

## KUSM-1200 Airspeed and Mach Number Indicator

The KUSM-1200 is a combined airspeed and Mach number indicator gauge and used for measurement of indicated airspeed from 100 to 1200 km/h, true airspeed from 300 to 1200 km/h and Mach number from 0.5 to 1, and for critical Mach ( $M=0.78$ ) indication. When the airplane reaches approx.  $M=0.78$ , the red "M max" warning light illuminates on the warning light panels in both cockpits and the air brakes extend automatically. The warning light operates in continuous mode. The KUSM-1200 is installed on both instrument panels in the front and rear cockpits.

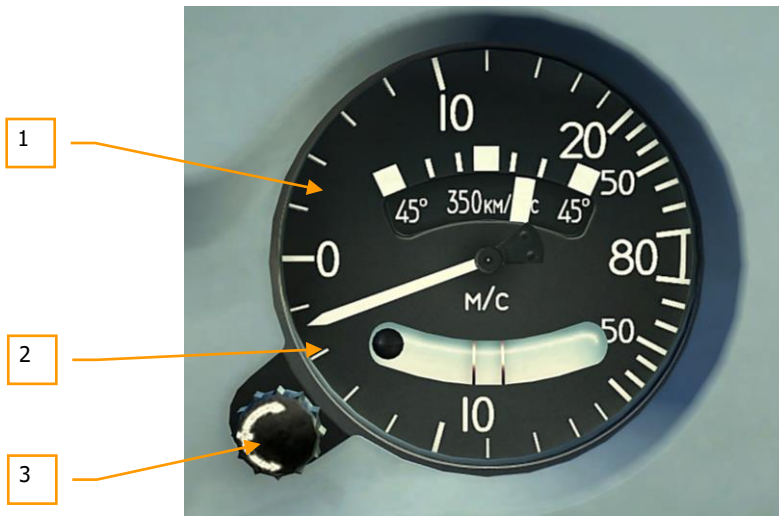

**Figure 111: KUSM-1200 airspeed and Mach number indicator**

1. Mach number scale
2. True airspeed pointer
3. Indicated airspeed pointer

## Combined Gauge Variometer

The variometer is intended to measure vertical speed. Variometers are installed on both instrument panels in the front and rear cockpits.



**Figure 112: Combined gauge variometer**

1. Climb rate scale
2. Descent rate scale
3. Variometer adjustment knob, for setting the variometer pointer to the "0" position

## Gyroscopic Instruments

- AGD-1 attitude directional indicator
- Electrical turn and slip indicator (T/S)
- Accelerometer

### AGD-1 Remote Artificial Horizon

The AGD-1 gives the pilot information about bank and pitch angles relative to the horizon, presence and direction of slip. The KPP-1273K is used as ADI gauge, which is a combination of artificial horizon pointer together with command and additional pointers. To use the SDU L-39 remote command landing system, the ADI has lateral and longitudinal channel pointers, as well as course deviation and altitude deviation pointers. The pointers are controlled by signals from the command landing system. The SDU-L39 provides semi-automatic airplane control during landing. This system is enabled by the SDU circuit breaker located on the main CB panel and by the SDU switch on the right panel in the front cockpit. To enable the ADI, it is necessary to enable the BATTERY and AGD-GMK CBs on the main electrical CB panel in the front cockpit. After pressing the cage (АППЕТИР) button, the lamp

illuminates and then goes off after not more than 15 seconds. The ADI will show zero angle of bank and pitch. 1.5 minutes after being enabled, the ADI should show actual bank and pitch angles. The ADI is installed on both instrument panels in the front and rear cockpits.

### KPP-1273K ADI

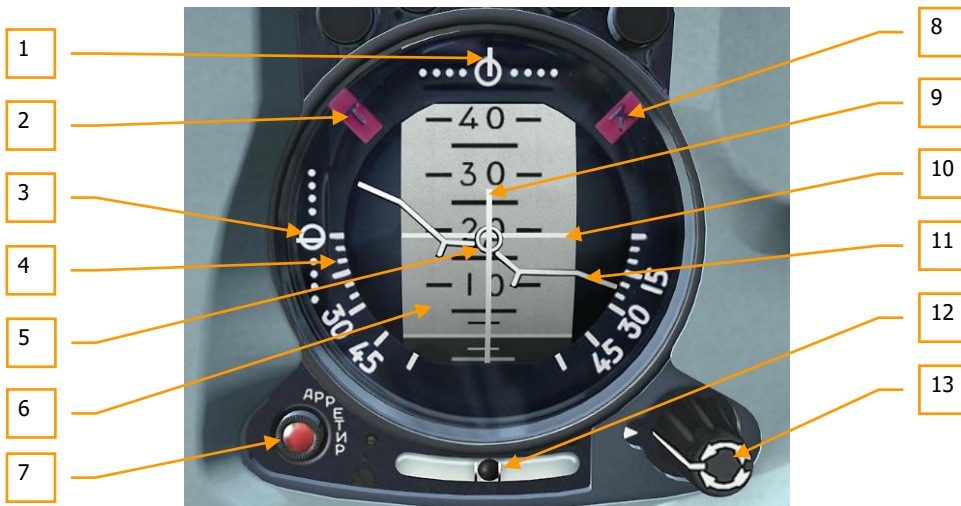

**Figure 113: KPP-1273K ADI**

1. Localizer (heading) deviation scale and pointer
2. SDU T warning flag, indicating absence of power in longitudinal (pitch – тангаж) channel of SDU remote command landing system
3. Glideslope (altitude) deviation scale and pointer
4. Bank angle scale
5. Miniature aircraft symbol / airplane datum
6. Pitch angle scale
7. Cage/arresting (АРРЕТИР) button with red light, for caging ADI and indicating ADI failure
8. SDU K warning flag, indicating absence of power in lateral (bank – крен) channel of SDU remote command landing system
9. SDU lateral (bank) channel command pointer
10. SDU longitudinal (pitch) channel command pointer
11. Bank angle indicator
12. Slip indicator
13. Pitch trim knob, for adjusting the pitch scale

The trainer seated in the rear cockpit can simulate KPP-1273K failure (pitch and roll scales) in the front cockpit.

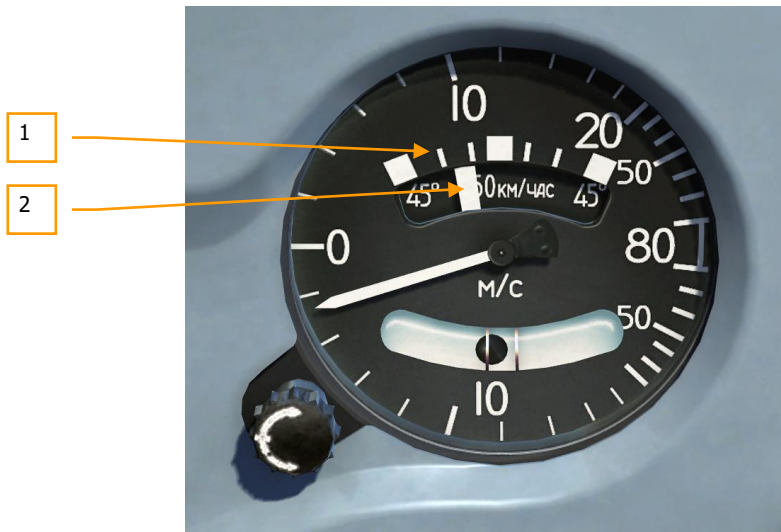

Figure 114: ADI failure simulation controls



## Electrical Turn and Slip Indicator

The turn and slip indicator determines turn and slip directions and bank angles at a speed of 350 km/h. The angular velocity measurement limit is  $\pm 5,7^\circ/s$ , which corresponds to  $45^\circ$  bank angle and a speed of 350 km/h. Bank scale intervals are  $15^\circ$ . To enable the electrical T/S indicator, it is necessary to enable the BATTERY and ENGINE CBs on the main electrical CB panel in the front cockpit. T/S gauges are installed on the instrument panels in both cockpits.



**Figure 115: Turn and slip indicator**

1. Bank scale
2. Turn pointer

## Accelerometer

The accelerometer is a device for measuring acceleration by leveraging the principle of inertia. It indicates the load factor (G forces) acting on the airframe and gives a warning signal when +7.5 or -3.5 G are being exceeded. Before flight, it is necessary to check if the gauge pointers are set to +1 G (equal to one times the force of gravity). If necessary, use the reset knob to move the needles to this position. No accelerometer is installed in the rear cockpit.

The gauge is graduated from -5 to +10 G and scaled to 0.5 G throughout. The 0 G indication is located at the 12 o'clock position. The two red markings indicate maximum permissible loads of -4 and +8 G. The instrument includes three needles:

- Current G pointer, continuously indicating the current acceleration (G) force experienced
- Maximum positive G force recording pointer, following the current G pointer and staying at the location on the dial where maximum positive G load is indicated, thus recording maximum positive force reading during flight since the last reset
- Maximum negative G force recording pointer, following the current G pointer and staying at the location on the dial where maximum negative G load is indicated, thus recording maximum negative force reading during flight since the last reset

The reset knob is used to reset the maximum and minimum needles to the 1 G position.



**Figure 116: Accelerometer**

1. Maximum negative G force recording pointer
2. Current G pointer
3. Maximum positive G force recording pointer
4. Reset knob

## AChS-1M Cockpit Chronograph (Clock)

The Molnija AChS-1M is an electrically heated aviation chronometer clock that displays the current time of day in hours and minutes. It can also be used to measure mission/flight time in hours and minutes, and as a chronometer to measure short periods of time (up to 30 minutes) in minutes and seconds.

The clock is installed on the instrument panels in the front and rear cockpits and consists of three mechanisms:

- a) time-of-day clock
- b) flight time indicator
- c) stopwatch to accurately measure short time periods



**Figure 117: AChS-1M clock**

1. 12-hour mission (flight) time clock dial
2. Outer dial, displaying current time of day
3. Left crown button, for winding the clock, setting the hour and minute hands of the outer dial, and changing the mode (start/stop/reset) of the flight time mechanism
4. Mode indicator window
5. 30-minute stopwatch clock dial
6. Right crown button, for starting/stopping the entire clockwork, and starting/stopping/resetting the stopwatch

The time of day display operates continuously. Flight (mission) time can be activated as desired by pressing the left (red) crown button [RAlt+RCtrl+RShift+C]. The stopwatch can be activated as desired by pressing the right crown button [RAlt+RShift+C].

To set the time, first stop the clock by rotating the right crown button, labeled ПУСК (START), clockwise [RCtrl+RShift+.] when the second hand points to 12. Then pull the left crown button [RShift+M] while holding down the right mouse button, and rotate it counter-clockwise [LAlt+.] or clockwise [LAlt+,] to set the desired time. Rotating the right crown button counter-clockwise [RCtrl+RShift+,] again resumes clock operation with the new time setting.

Flight (mission) time is indicated on the small scale at the top of the clock face. Flight time mode is indicated by the following three markings inside the mode indicator window:

- Red: Flight time is running.
- Red-white: Flight time is stopped.
- White: Flight time is reset (standby).

Press the left crown button [RAlt+RCtrl+RShift+C] to start the timer. The mode indicator window will show red and the timer will start ticking. To stop the timer, press the left crown button again. The mode indicator window will show red-white. To reset the timer, press the left crown button once again. The mode indicator will now show white.

The stopwatch is the small scale at the bottom of the clock face and is used to accurately measure short time spans (up to 30 minutes). It is controlled with the right crown button: Press the right crown button to start the timer, press it again to stop the timer and press it once again to reset the timer.

The clock spring is wound manually by rotating the left crown button counter-clockwise to its mechanical stop. The spring contains enough energy for two days of operation.

## Heading Measurement

For heading measurement, the following units are installed:

- KI-13 magnetic compass
- GMK-1AE directional gyro

### KI-13 Magnetic Compass

The KI-13 magnetic compass is designed for airplane heading determination in case of GMK-1AE failure. It has an individual backlight. The KI-13 compass is not installed in the rear cockpit.



**Figure 118: KI-13 magnetic compass**

## GMK-1AE Directional Gyro

In the L-39C simulator, flight can be performed with magnetic or true heading.

GMK-1AE is designed for heading and turn angles determination. Heading is indicated on Radio Magnetic Indicator (RMI).

To turn on the RMI, it is necessary to enable the BATTERY and AGD-GMK circuit breakers on the main CB panel in the front cockpit. An RMI is installed on both front and rear cockpit instrument panels. To control the GMK-1AE system in the front cockpit on the right panel PU-26E control panel is installed and in the rear cockpit on the right panel the KM-8 correction mechanism is installed. The KM-8 is designed for entering magnetic variation in the system.

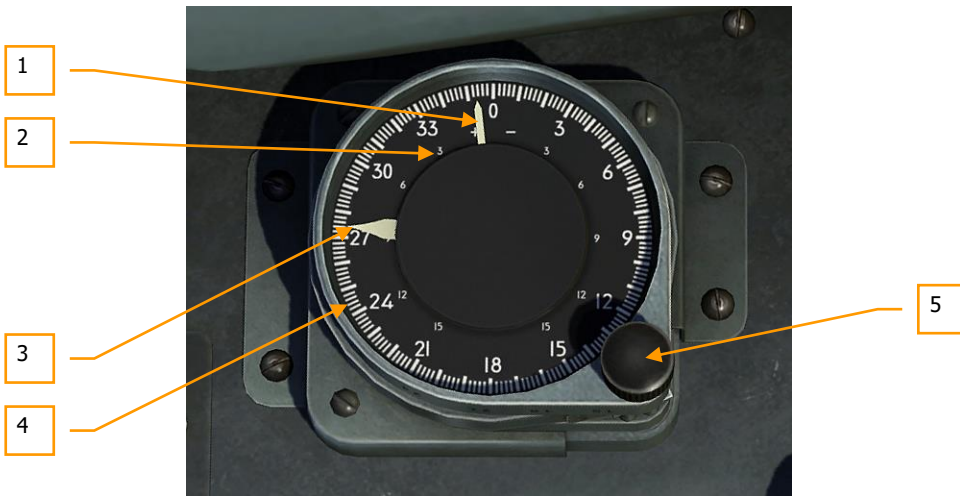
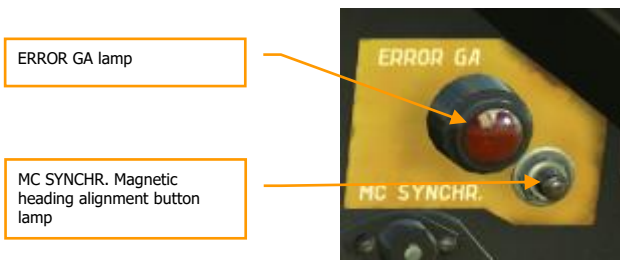

**Figure 119: KM-8 correction mechanism**

1. Magnetic variation pointer
2. Magnetic variation scale
3. Heading pointer
4. Heading scale
5. Magnetic variation knob

To align the system with the magnetic heading, it is necessary to press the MC SYNCHR. button in the front or rear cockpit, or press the HDG SELECT switch on the PU-26E control panel in the front cockpit. In flight after 45 min, one of the pilots has to re-align the system.

In case of gyroscope blockage, the ERROR GA warning light is illuminating on the panel (can illuminate after vigorous maneuvers), the system has to be aligned as well. Alignment has to be performed in straight and horizontal flight with a constant speed.



ERROR GA lamp

MC SYNCHR. Magnetic heading alignment button lamp

**Figure 120: ERROR GA lamp**

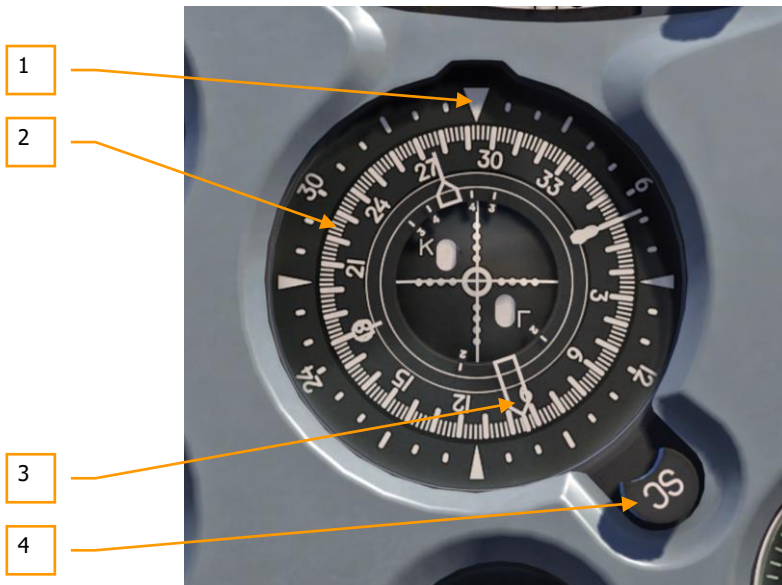

**Figure 121: RADIO MAGNETIC INDICATOR (RMI)**

1. Fixed heading index
2. Heading scale
3. Course pointer
4. Course knob

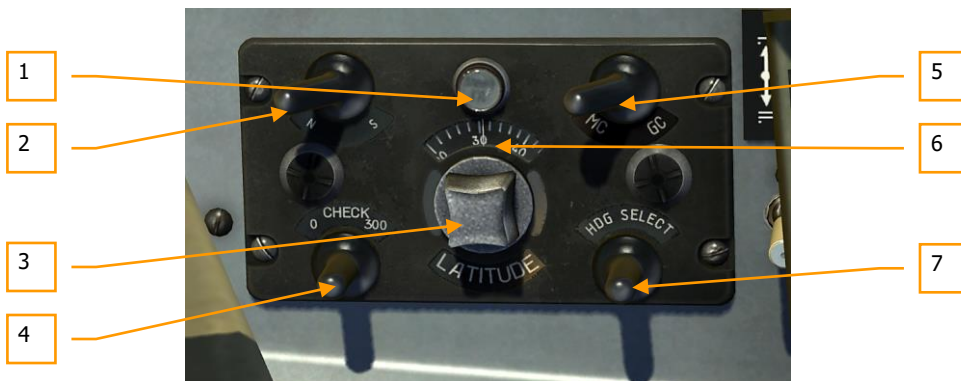

**Figure 122: PU-26E control panel**

1. ERROR GA lamp
2. "N – S" (NORTH - SOUTH.) switch is designed to set northern or southern hemisphere
3. Latitude selector. The latitude of location where the navigation flight is to be flown can be set by latitude selector. The latitude setting is required due to automatic correction of GMK gyfo position in GC mode. The selected latitude can be read on scale above the selector.
4. Test switch. The test switch verifies the correct operation of the GMK system in the MC mode. The test can be executed after terminating the GMK starting process, which lasts 3 minutes in MC mode or 5 minutes in GC mode. When the test switch "CHECK" is moved to 0 (zero) position, the RMI compass card shall rotate to position zero degrees, when in 300 degrees position the compass card shall indicate 300° heading. The allowable indication tolerance is  $\pm 10$  degrees. The compass card repositioning shall be accompanied by illumination of the gyro drift indicator on both the GMK control box and front control panel. When the test switch is released to its center neutral position, the HSI compass card shall rotate back and indicate actual heading.
5. MC – GC (Magnetic correction-Directional gyro mode) switch
6. Latitude scale
7. Heading switch. If the GMK operates in MC mode, moving the HDG. SELECI switch to either position will align the GMK gyro with magnetic heading. If the GMK operates in GC mode, moving the HDG. SELECI switch to either position will cause the gyro rotation in the respective direction hence rotating RMI compass card. The gyro (compass card) rotation is terminated when the heading switch is released to its center neutral position, and the GMK proceeds operation in GC mode with new gyro setting.

Trainer from rear cockpit can simulate GMK-1AE failure in front cockpit.





**Figure 123: Control of GMK-1AE failure simulate**

## Airplane Oxygen Equipment

There is a certain specific in oxygen equipment usage in the L-39 simulator. A pilot flies in a helmet and oxygen mask, anti-G suit can be used as well. Oxygen mask is always attached to the helmet. Sealed helmet, high-altitude and ventilation suits are not used, as well as their controls.

The KKO-5 oxygen equipment set is installed on the airplane.

It is designed to provide normal pilot normal operating conditions at high altitudes and to provide safe ejection at any altitude. Before flight pilots has to ensure that KKO controls are in correct positions.

The KKO-5 is installed in front and rear cockpit.

## KKO-5 controls

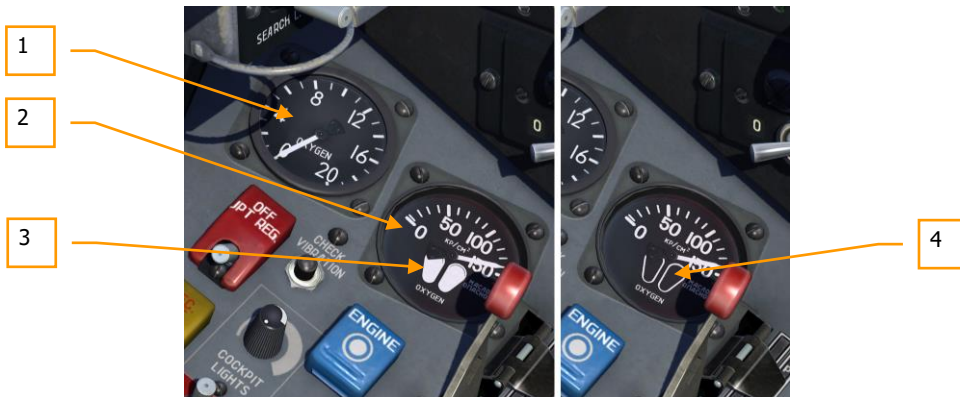

**Figure 124: KKO-5 controls**

1. M-2000K excessive pressure gauge monitors excessive pressure in breathing system. It is located on the left panel in front cockpit and not-operational in the simulator.
2. IK-52 oxygen pressure indicator and flow annunciator is used for monitoring oxygen supply for breathing as well as for measuring pressure in air tanks. It is installed on the left panels in both cockpits. Flags indicators converge during inhale and diverge when exhaling.
3. Inhalation indication
4. Exhalation indication

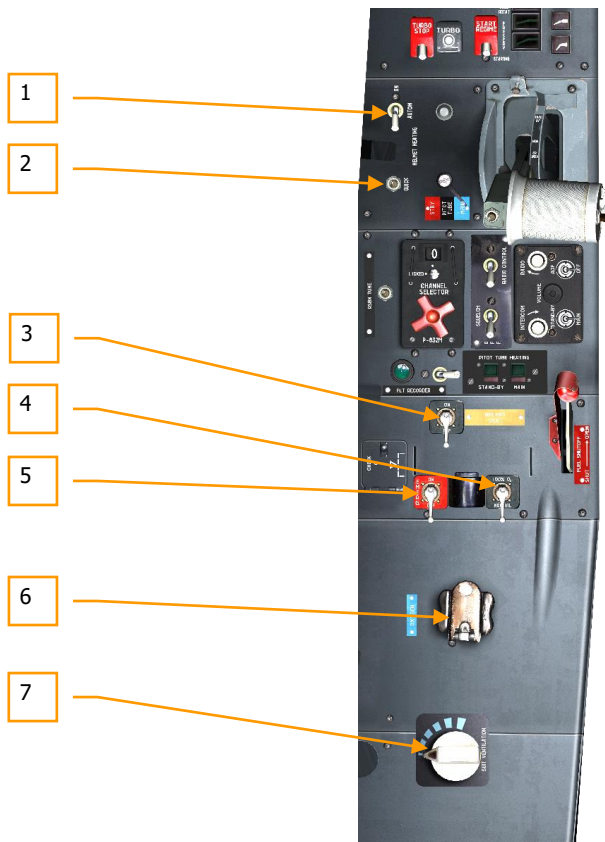

**Figure 125: KKO-5 controls on the left panel in front cockpit**

1. HELMET HEATING – enables helmet visor heating, located on the left panel in front cockpit. Not used in simulator.
2. QUICK HELMET HEATING – for fast heating of helmet visor, installed on the left panel in front cockpit. Not used in simulator.
3. HELMET VENT used for helmet ventilation, installed on the left panel in front cockpit. Not used in simulator.
4. RPK-52 oxygen regulators. The RPK-52 has the following handles: 100% O<sub>2</sub> – NORMAL for automatic oxygen supply regulation depending on altitude, installed on left panels in both cockpits.
5. EMERG ON- OFF valve enables continuous oxygen supply.
6. KV-2MS oxygen valves supply oxygen from tanks to oxygen system.
7. SUIT VENTILATION valve is used for VK-3M (ventilation suit) ventilation and located on the left panel in front cockpit. Not used in simulation.

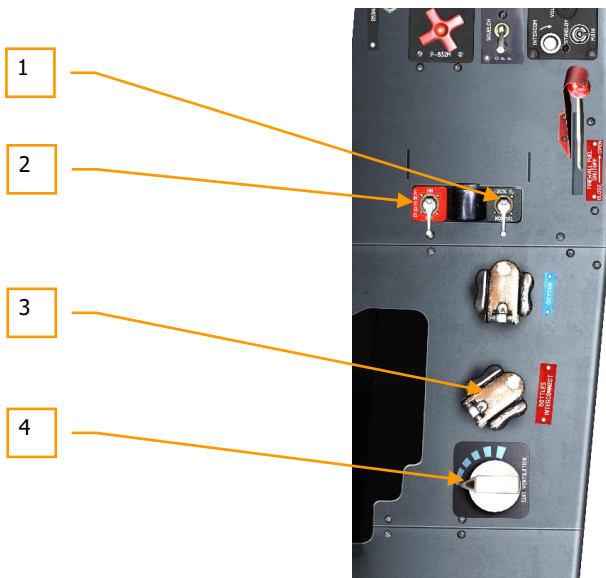

**Figure 126: KKO-5 controls on the left panel in rear cockpit**

1. RPK-52 oxygen regulators. The RPK-52 has the following handles: 100% O<sub>2</sub> – NORMAL for automatic oxygen supply regulation depending on altitude, installed on left panels in both cockpits.
2. EMERG ON- OFF valve enables continuous oxygen supply.
3. KV-2MS BOTTLES INTERCONNECT oxygen valve connects front and rear cockpit air lines. Located in rear cockpit.
4. SUIT VENTILATION valve is used for VK-3M (ventilation suit) ventilation. Not used in simulation.

KKO-5 operation depending on altitude:

- Up to 2 km pilot breathes in cockpit air
- From 3 km to 8km – oxygen-air mixture
- From 8 km to service ceiling – pure oxygen

At altitudes lower than 2 km, if the RPK-52 100%O<sub>2</sub> – NORMAL handle is set into the NORMAL position, oxygen is not supplied and IK-52 oxygen pressure indicator and flow annunciator flags do not react on inhaling and exhaling.

## SARPP-12GM Flight Data Recorder

The system is designed for recording flight parameters, various systems status, and for storing information received in normal and emergency conditions.

System switching on and off is performed by the BATTERY switch on the main CB panel in the front cockpit and by switch with inscription: FLT RECORDER, which is placed on the front cockpit left panel. After this system is turned on, the green lamp, located near the FLT RECORDER switch, starts blinking. If pilot did not enable the FLT RECORDER switch, SARPP-12GM FDR will be enabled automatically when the speed reaches 120 km/h.

In DCS: L-39C, the SARPP-12GM FDR is implemented in the following way: while watching recorded track it is possible to open window with recorded flight parameters.



**Figure 127: SARPP-12GM flight data recorder controls**

## Radio Electronic Equipment

The radio electronic equipment of the L-39 is divided in:

1. Communication
2. Navigation
3. Radar

### R-832M Command Radio

It is developed for duplex communication between airplanes and ATCs.

The R-832M is enabled with the following automatic circuit breakers on the main CB panel: BATTERY, 115V INVERTOR I, 115V INVERTOR II, and RDO. After all the CBs are enabled, one should make sure that the channel number lamp illuminates. After 2-3 minutes, the R-832M is operational.

R-832M controls:

- control unit on the left panel in both cockpits
- «РАДИО» (RADIO) PTT button on the throttle handle in both cockpits

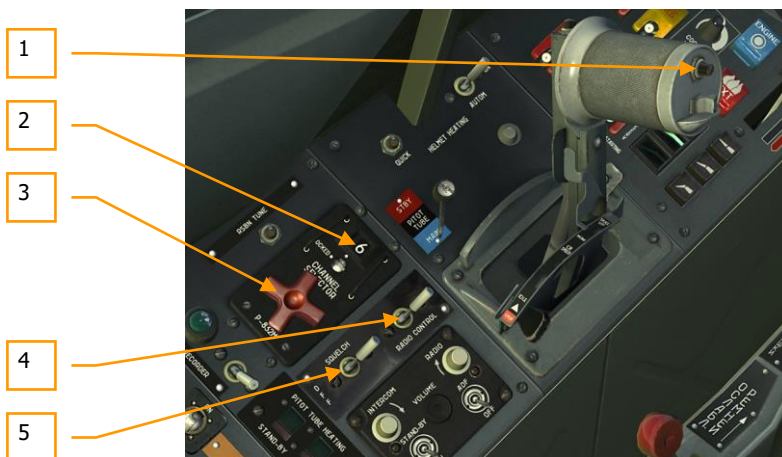

**Figure 128: R-832M controls**

1. RADIO PTT button
2. Selected channel number
3. CHANNEL SELECTOR rotary switch for changing channels
4. RADIO CONTROL switch to connect transmitter to the front cockpit or rear one (control is performed by channel number illumination)
5. SQUELCH switch to turn off noise suppression system

## SPU-9 Intercom

This intercom is designed to provide communication between the crew members and for hearing RKL-41, RSBN-5S, MRP-56P, RV-5 and accelerometer sound signals.

The SPU-9 is enabled by the BATTERY, 115V INVERTOR I, 115V INVERTOR II and RDO CBs on the main CB panel. To communicate with ground crew, a "ground" intercom is installed and can be enabled by the INTERCOM GROUND switch, located on the right panel in rear cockpit.

SPU-9 controls:

- two control panels on the left panel in both cockpits near the R-832M control panel;
- SPU INTERCOM button on the throttle handle in both cockpits and on the stick in the rear cockpit;
- INTERCOM GROUND – on the right control panel in the rear cockpit.

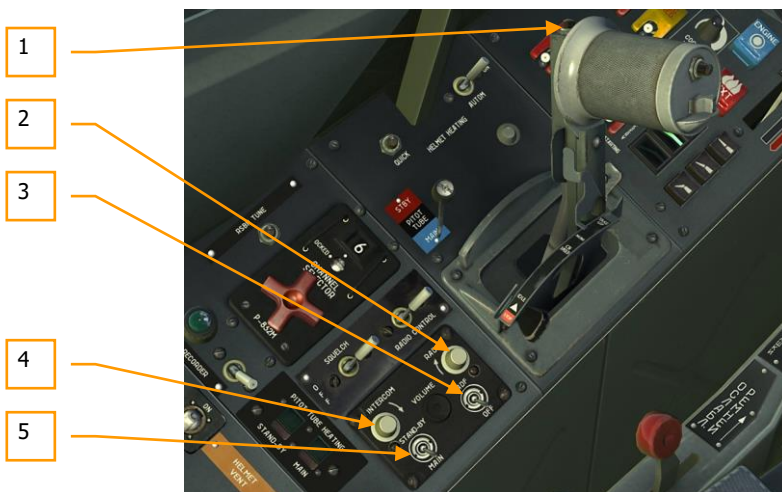

**Figure 129: SPU-9 controls**

1. SPU INTERCOM button
2. RADIO volume knob to adjust external radio channels and self-listening signals volume.
3. ADF switch – for listening to outer and inner NDBs signals.
4. Intercom volume knob.
5. MAIN- STANDBY switch for switching SPUs between the cockpits.

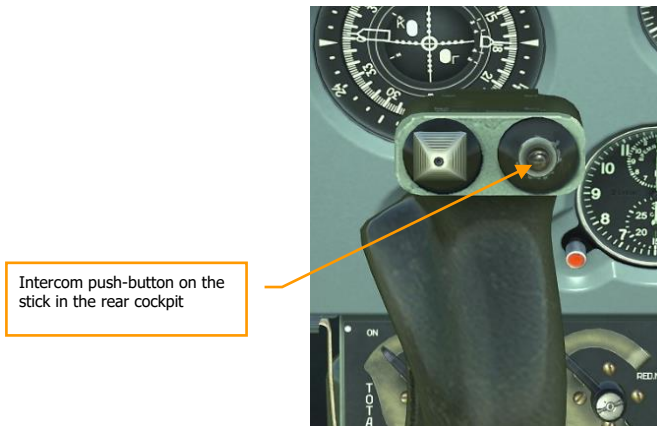

Intercom push-button on the stick in the rear cockpit

**Figure 130: Intercom push-button on the stick in the rear cockpit**

## Radio Navigation Equipment

The radio navigation equipment consists of:

- RKL-41 automatic direction finder
- RSBN-5S (RSBN) system
- RV-5 low altitude radar altimeter
- MRP-56P marker beacon receiver

### RKL-41 Automatic Direction Finder

It is designed for NDBs' heading determination.

The RKL-41 is enabled by the BATTERY, 115V INVERTOR I, 115V INVERTOR II, and RDO CBs located on the main CB panel.

RKL-41 controls:

- Two control panels, located on the right panels in both cockpits
- O-I (Outer NDB – Inner NDB) switch, located at the bottom left from the instrument panel in front and rear cockpits
- RKL-41 gauge, installed on instrument panels in both cockpits





**Figure 131: RKL-41 ADF gauge**

### RKL-41 controls

Outer - Inner NDB selector is located below the instrument panel in front and rear cockpits



**Figure 132: RKL NDB selector**

RKL-41 control panel



**Figure 133: RKL-41 Control Panel**

1. Volume knob
2. Tuning indicator, designed for precise RKL tuning to the required frequency based on the maximum pointer deflection
3. Decade switch with "O" index is designed for entering frequency of outer NDB. External ring handle sets hundreds of kHz and internal handle tens of kHz.
4. Decade switch with "I" index is designed for entering frequencies of inner NDB. External ring handle sets hundreds of kHz and internal handle tens of kHz.
5. Precise tuning handle is designed for RKL tune based on maximum signals audibility in the TLF (Telephone) mode and on the maximum pointer deflection in TLG (Telegraph) mode.
6. Internal (flag) handles
7. External ring handles
8. Control panels switch is designed to switch control panels to front or rear cockpit. The RKL is connected to a control panel on which backlight lamps illuminate.
9. TLF – TLG switch is designed to connect reception path filters.
10. Mode switch OFF, C AUT, C MAN, ANT, LOOP. "C AUT" (Compass automatic) and "C MAN" (Compass Manual) are RKL primary operating modes, NDBs' direction determines automatically. The only difference is that in "C MAN" mode there is no automatic switching from outer NDBs to the near one. In the "ANT" (Antenna) mode direction to the NDBs is not determined. It is used to adjust RKL ADF to the NDB frequency. The "LOOP" mode is designed for finding radio stations direction by hearing.
11. Illumination brightness adjust handle
12. L-R (Left-Right) switch is designed for manual antenna rotation.

## RKL-41 Direction Finder Checking and Tuning

Enable the BATTERY, 115V INVERTOR I, 115V INVERTOR II, and RDO CBs on the main CB panel in front cockpit and perform the following actions:

1. On SPU-9 intercom control panel set the "PK – BblK" switch into PK position
2. On ADF control panel:
  - "O-I" switch on the instrument panel set in the O position
  - ADF control panel switch set in your cockpit position
  - Set maximum volume, by turning the volume knob to the most right position
  - Turn on ADF by turning the selector switch from OFF position to ANT position by that control panel and tuning indicator illumination will be switched on
  - TLG — TLF switch install in the TLF position
  - Set outer NDBs' frequency by turning knob on the O decade, maximize callsigns outer NDB audibility by precise tuning knob
  - TLG — TLF switch set to the TLG position and adjust radio compass by tuning precise tune knob to the outer NDB frequency based on maximum pointer deflection to the right
  - TLG — TLF switch set to the TLF position;
  - Set mode switch to the "C AUT" or "C MAN" position, ADF will show outer NDB bearing
  - by setting L—R selector alternatively to the L and R positions, deflect pointer at 160°, return selector to the neutral position, pointer should point outer NDB heading angle
  - O—I set in the I position, perform ADF tune on inner NDB frequency by I decade tuning knobs and check its operation in the same way as for outer NDB
3. After checking set the O-I switch in the O position
4. Set the ADF—OFF switch on the SPU-9 control panel in OFF position

Trainer from rear cockpit can simulate RKL-41 failure in front cockpit



**Figure 134: RKL-41 failure simulate switch**

## RSBN-5S "ISKRA-K" Short Range Navigation System

### Onboard Equipment

The RSBN-5S (the "S" stands for "airplane" – "samolet" in Russian) airplane equipment is a part of RSBN-4N (the "N" stands for "ground" – "nazemnoe" in Russian) short-range radio navigation system. Airplane part together with ground equipment are used for polar coordinates determination (azimuth and distance).

With help of ground part of instrumental landing system (PRMG-4 beacon group) the RSBN-5S system assists landing.

Before instrumental flight with help of Iskra-K equipment, the pilot has to set navigation and landing channels on the control panel in front cockpit.

The RSBN-5S can operate in three modes: NAV (Navigation), GP (Glide path) and LANDING.

In NAVIGATION mode, the system shows:

- Airplane bearing on RMI
- Distance to ground station on PPD-2
- Autonomous computing of aircraft location beyond the radio signal range of station

In GLIDE PATH mode, the system shows:

- Airplane bearing on RMI
- Distance to ground station on PPD-2
- Deviation from required course with course deviation pointer on RMI
- Programmed descending trajectory (descending curve) using glide-slope pointer on RMI

Descend termination point is marked with END OF DESCENT signal on caution & advisory lights panel in both cockpits. Signal operates in continuous mode.

In the LANDING mode

- Indication that airplane within operating range of course and glide-slope beacons
- Deviation from glide-slope trajectory using glide-slope pointer on RMI
- Deviation from landing course with course deviation pointer on RMI
- Distance to distance re-translator, which is included in glide slope beacon

Detailed description on how to use the RSBN-5S system is found in chapter 3 of this manual.

The RSBN-5S is enabled by the BATTERY, 115V INVERTOR I, 115V INVERTOR II and AGD-GMK (96), RSBN (ISKRA system) switches on the main CB panel in front cockpit.

RSBN (Iskra) – after 3 minutes being enabled, RMI and PPD should show NDB bearing and distance to NDB. On the RSBN-5S control panel AZIMUTH CORRECTION and DISTANCE CORRECTION and in rear cockpit AZIMUTH CORRECT and DISTANCE CORRECT signals go on.

RSBN-5S controls and indicators:

- RMI device is located on both cockpits instrument panels
- PPD-2 device is located on both cockpits instrument panels
- RSBN-5S control unit is located on right panel in front cockpit

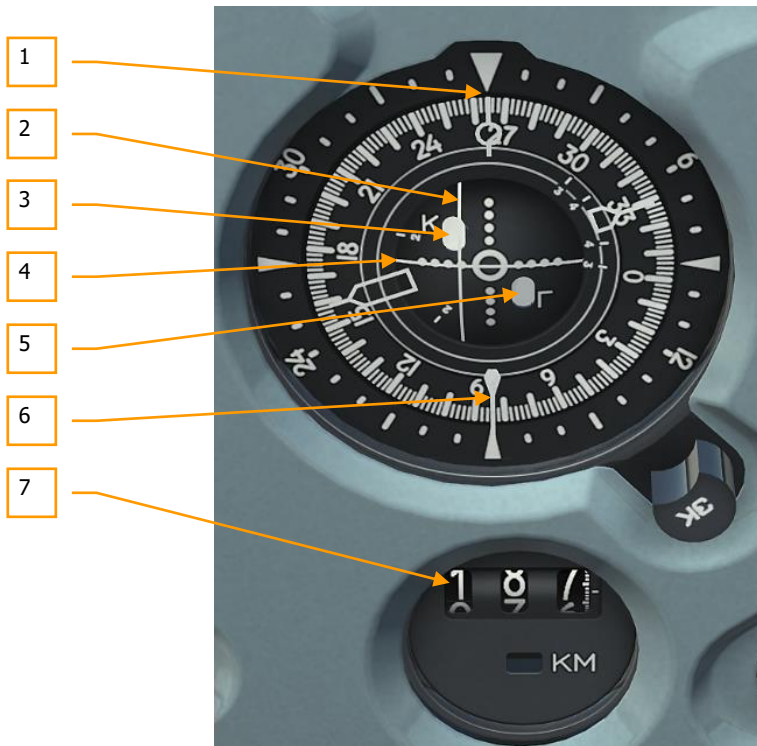

**Figure 135: RMI and PPD-2**

1. Airplane heading
2. Heading deviation pointer
3. Heading flag
4. Glideslope deviation pointer
5. Glideslope flag
6. Direction to the airfield
7. PPD-2 RSBN range indicator

### RSBN-5S Controls in Front Cockpit

RSBN TUNE button. By pushing it RSBN ground beacon callsigns are heard, installed on the left panels in front and rear cockpits.



Figure 136: RSBN TUNE button



Figure 137: RSBN-5S Controls in Front Cockpit

1. LANDING-NAVIGATION-GLIDE PATH mode selector switch
2. IDENTIF button by pushing it a personal identification signal is generated on the round view indicator. This function is not implemented in the simulator
3. TESTING button is designed to check the azimuth and distance measuring channels
4. RSBN LIGHTING knob adjusts brightness
5. AZIMUTH INITIAL SETTING. The AZIMUTH INITIAL SETTING switch, once positioned to either side, rotates the RMI's compass card. Releasing the switch, the new azimuth is set.
6. DISTANCE INITIAL SETTING. The DISTANCE INITIAL SETTING switch, once positioned to either side, decrease or increase the distance displayed on the RSBN range indicator (PPD-2). Releasing the distance switch, the new range is set.
7. Landing channel indication
8. Navigation 40-channel switch, designed to select navigation channels
9. Landing 40-channel switch is designed to select landing channels
10. AZIMUTH 0 SETTING button is designed for azimuth channel calibration check
11. Navigation channel indication
12. VOLUME CONTROL knob is designed to adjust volume of RSBN ground beacons callsigns
13. AZIMUTH/DISTANCE CORRECTION signal lamps are designed to control the azimuth and distance measurement channels operation

ZDV-30 is designed to set the airfield pressure for RSBN mode GLIDE PATH.



**Figure 138: ZDV-30**

### Operating ISKRA-K from Rear Cockpit

RSBN Iskra-K controls are mostly located in front cockpit. In rear cockpit on the right console there is an AZIMUTH ACCORDANCE button and EMERGENCY SWITCH FOR LANDING switch. To align rear cockpit azimuth (course) on HIS with that of front cockpit pilot has to push AZIMUTH ACCORDANCE

button in rear cockpit. While aligning RMI glide-slope deviation pointer is being hold in center position and CONFORM. AZIMUTH signal on the front cockpit caution & advisory lights panel is on.

The rear cockpit pilot, who took over airplane control and performs landing should enable the EMERGENCY SWITCH FOR LANDING switch and manually set desired landing heading on RMI.

In all cases it is possible to land airplane on the airfield, frequency channel of which is set on the RSBN control panel in front cockpit.

To verify azimuth and distance channels functionality there are two signals [AZIMUTH CORRECT](#) and [DISTANCE CORRECT](#) signals on caution & advisory lights panel.



**Figure 139: RSBN-5S controls in rear cockpit**

1. AZIMUTH ACCORDANCE button
2. EMERGENCY SWITCH FOR LANDING switch

## RV-5 Low Altitude Radar Altimeter

The RV-5 low altitude altimeter is intended to determine real altitude over surface within 0-750m range. Besides that, it gives information to the pilot about descent on pre-installed on the device dangerous altitude and about device failure. When airplane reaches altitude, which was set on the gauge as dangerous the DANGEROUS ALTITUDE signal starts blinking. If flying higher than RV-5 operating range, warning flag is seen on the altimeter gauge and pointer is set behind the dark sector of the scale.

The RV-5 altimeter is enabled by the BATTERY, 115V INVERTOR I, 115V INVERTOR II and MRP-RV CBs located on the main CB panel in front cockpit.

1-2 minutes after being enabled, the radar altimeter pointer deflects all the way to the right and returns to zero with  $\pm 1$  m precision. If the radar altimeter pointer is below the DANGEROUS ALTITUDE index, continuous audio signal (4-9 seconds) is heard in pilot's headphones, the DANGEROUS ALTITUDE signal and DANGEROUS ALTITUDE signal lamp on the RV-5 gauge go on.

RV-5 controls and indication units:

- Altitude pointer is located on the instrument panel in front and rear cockpit



- DANGEROUS ALTITUDE signal is located on the warning lights panel in both cockpits

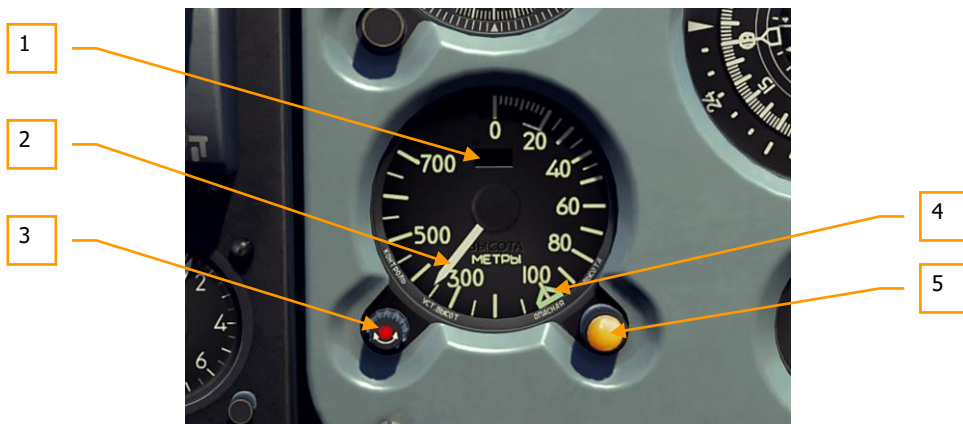

**Figure 140: RV-5 Low Altitude Radar Altimeter**

1. Radio altimeter failure warning flag
2. Altimeter pointer
3. Knob, setting dangerous altitude
4. Dangerous altitude index
5. DANGEROUS ALTITUDE lamp

### MRP-56P Marker Beacon Receiver

It is designed to determine the fly over the marker beacon moment. When the airplane is flying over a marker beacon, the MARKER light on the caution & advisory lights panel of both cockpits blinks and the marker beacon callsign is heard. Marker beacons are installed on the outer and inner NDBs. MRP-56P is enabled by the BATTERY, 115V INVERTOR I, 115V INVERTOR II, and MRP-RV CBs located on the main CB panel in front cockpit.

# FLIGHT



# FLIGHT

## L-39C Structural Limits

No	Limitation	Limited by
1.	Maximum takeoff weight: paved runway— 4700 kg. unpaved runway— 4600 kg.	Airplane durability
2.	Maximum landing weight —4500 kg. (in special cases—4600 kg)	Landing gear durability
3.	Maximum allowed IAS (up to 1300 m) —900 km/h	Airplane durability
4.	Maximum allowed Mach (higher than 1300 m) —0,8	Airplane stability and controllability
5.	Maximum allowed G-factor: for flight weight 4200 kg and less: <ul style="list-style-type: none"> <li>• positive — 8;</li> <li>• negative — 4;</li> </ul> for flight weight more than 4200 kg: <ul style="list-style-type: none"> <li>• positive — 7;</li> <li>• negative — 3,5;</li> </ul> for flight with extended flaps: <ul style="list-style-type: none"> <li>• positive — 2;</li> <li>• negative — not allowed</li> </ul>	Airplane durability
6.	Minimum allowed IAS – 200 km/h	Lift factor slack before stalling starts
7.	Maximum allowed IAS: with extended gears — 340 km/h with extended flaps (takeoff and landing position)—310 km/h	Landing gear doors and landing gear linkage durability
8.	Maximum allowed IAS for elevator trimmer usage— 700 km/h	Excessive trimmer efficiency at higher speeds
9.	Maximum time of inverted flight — 20 seconds	Amount of fuel in fuel accumulator
10.	Minimum time of horizontal flight between consecutive inverted flights — 20 seconds	Time needed to refuel fuel accumulator
11.	The maximum lateral wind component during take-off and landing — 10 m/s	Lateral stability and controllability of the airplane
12.	Maximum speed when braking can be started - 190 km/h	Brakes capacity
13.	Maximum taxi speed during turn —10 km/h	Airplane stability
14.	Maximum allowed IAS with jettisoned canopy —350 km/h	Impact of airflow on a pilot

№	Limitation	Limited by
15.	Maximum altitude when using of takeoff mode is allowed — 10000 m	Heat dissipation capacity of the engine
16.	Maximum duration of continuous operation of the engine at takeoff mode — 20" minutes	Engine durability
17.	Maximum allowed EGT: * up to 8000 m — 685°C (with anti-icing system enabled — not more 705°C); * higher than 8000 m — 715°C; * at idle and during engine start at all altitudes — 600°C	Heat dissipation capacity of the engine
18.	Maximum allowed HPC RPM — 107,8%	Engine durability
19.	Maximum duration of engine operation when fuel is supplied by emergency fuel system — 40 minutes	Automatics reliability
20.	Minimum HPC RPM, while fuel is supplied by emergency fuel system: * up to 2000 meters — 56%; * higher than 2000 m and more — 60%	Engine operation stability slack
21.	Maximum HPC RPM, while fuel is supplied by emergency fuel system: * up to 2000 meters — 103%; * higher than 2000 m and below 8000 m — not more than 99%	Engine operation stability slack
22.	Maximum altitude of flight, while fuel is supplied by emergency fuel system — 8000 m	Fuel system altitude performance
23.	Maximum altitude of flight with booster pump disabled — 6000 m	Engine operation stability
24.	Maximum altitude of flight with anti-icing system enabled - 8000 m	Heat dissipation capacity of the engine
25.	Maximum altitude for air engine start — 6000 m	Engine start reliability
26.	Minimum HPC autorotation RPM, needed for engine start without Sapphire-5 APU – 15%.	Engine start reliability
27.	Duration of engine operation at HPC RMP of 74—78% and 86—90% - minimal (use only as intermediate modes).	Compressor's air bleeding valves triggering
28.	Maximum wind speed blowing into the engine nozzle during engine start and testing – 10 m/s.	Engine start reliability and operation stability

# Engine Start Preparation

## Cold start

**Automatic engine start procedure is activated by key combination: [L. Win + Home]**

Engine should be started from the front cockpit, because STOP latch, which allows moving the throttle from the STOP to the IDLE and further, located on the front cockpit throttle only.

Engine can be started using ground power or battery.

Enable:

- **BATTERY** (Battery) CB, the following signals should go on:
  - ENG. MIN. OIL PRESS.
  - GENERATOR.
  - EMERGENCY GENERATOR.
  - DON'T START.
  - CANOPY UNLOCKED.
  - AIRCONDIT OFF.
  - INV. 3x36V FAIL.
  - INV. 115V FAIL.
  - master caution panel.

If pressure in the hydraulic system is less than  $100 \pm 5 \text{ kg/cm}^2$  the HYD. SYST. FAIL signal is on.

Voltammeter should indicate not less than 24V.

If ground power is connected, signal with ground equipment icon should be on and voltammeter should indicate 27-29 V.



- **ENGINE** CB on main CB panel, as a result signals DON'T START and INV. 3x36V FAIL should go off.
- **115V INVERTOR I** and **115V INVERTOR II** circuit breakers (signal INV. 115V FAIL goes off).
- **RDO CB.**
- **FLT RECORDER.**

Before engine start pilot must:

- Set inner and outer NDBs frequencies on RKL-41.
- Set navigation and landing channels on RSBN-5S control panel.
- Set airfield atmospheric pressure on ZDV-30.
- Set required communication channel on R-832M.
- Set MC – GC switch into MC position, N – S switch in N, set the latitude of the airfield.

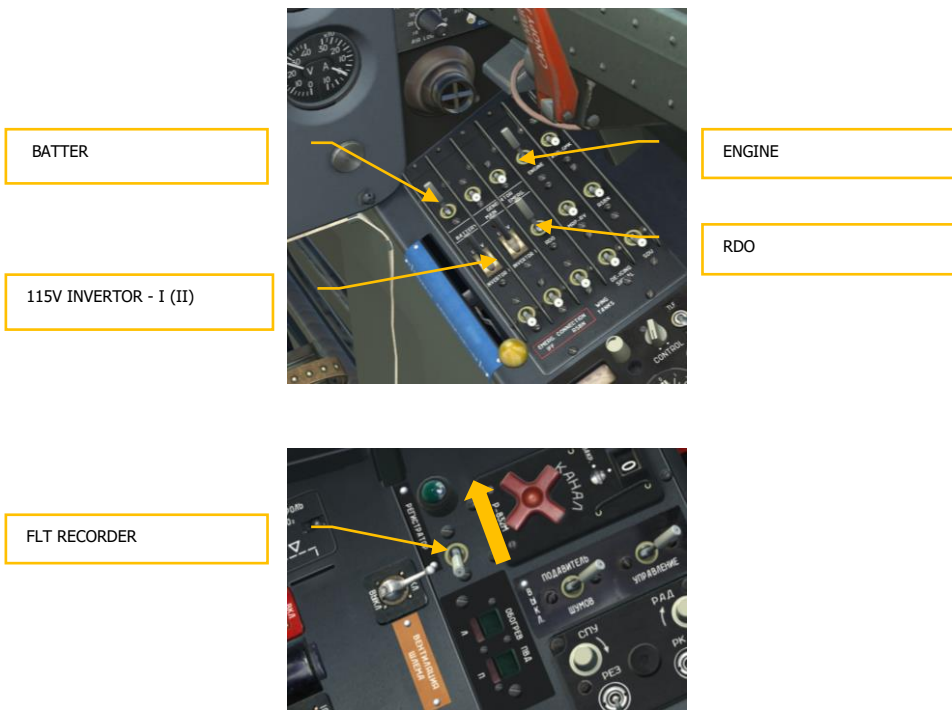

If start is going to be performed with help of ground power, pilot should request ground power connection from the ground crew [\] (**radiomenu**), [F8], [F2], [F1] (**connect ground power**).

Set the wheel chocks under the main landing gear: [\] (**radio menu**), [F8], [F4], [F1] (**set wheel chocks**).

Ask permission to start engine [ \ ] (radio menu), [F5], F3 (Permission to start) and once received, disable:

- **115V INVERTOR I CB.**
- **115V INVERTOR II CB.**
- **RDO CB.**

## Perform Engine Start

- Make sure that throttle is in STOP position and that DON'T START and INV. 3x36V FAIL signals are off.
- Start Sapphire-5 APU, for that simultaneously press stopwatch button and TURBO button for 1-2 seconds.
- Listen if APU has started and move sight to the caution & advisory lights panel, after 23-24 seconds, TURBINE STARTER signal flashes on. Now the engine can be started.

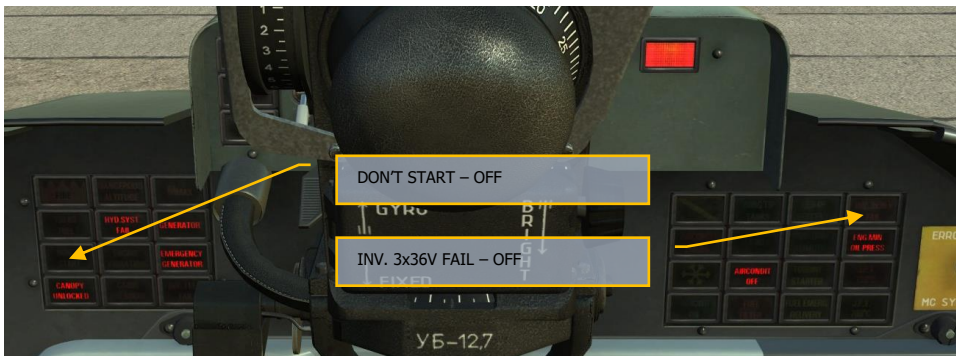

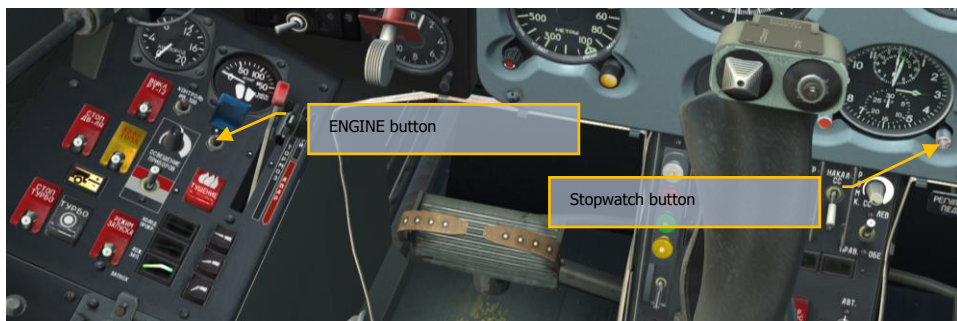

- After 3 – 6 seconds from the moment button was pressed move the throttle to the IDLE position [RAIt + Home].





After 3 – 6 sec. set throttle to IDLE

- Look at engine RPM gauge, HPC (n1) RPM should increase constantly and at 15<sup>th</sup> second, from the moment the ENGINE button was pressed, should be not less than 20%. From this point LPC (n2) RPM should start increasing as well.

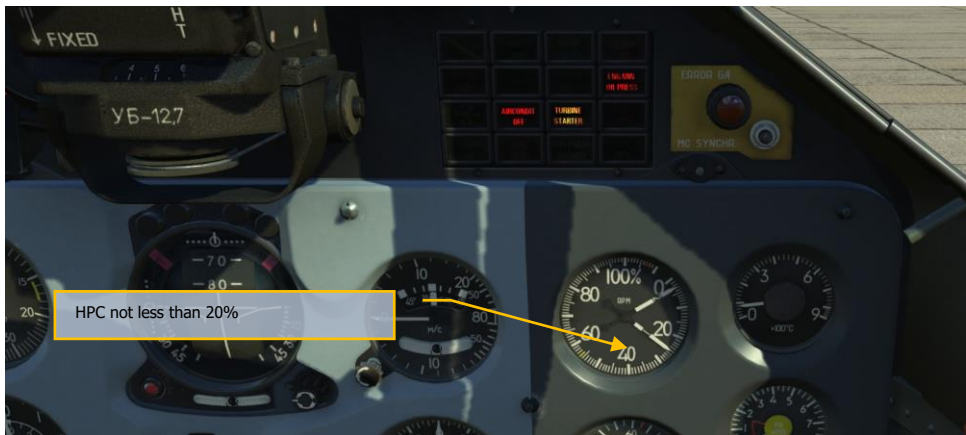

- Look at EGT gauge and as soon as temperature stop increasing, look back at the engine RPM gauge, HPC and LPC RPMs should be gradually increasing and reach values corresponding to IDLE mode.
- Press stopwatch button.

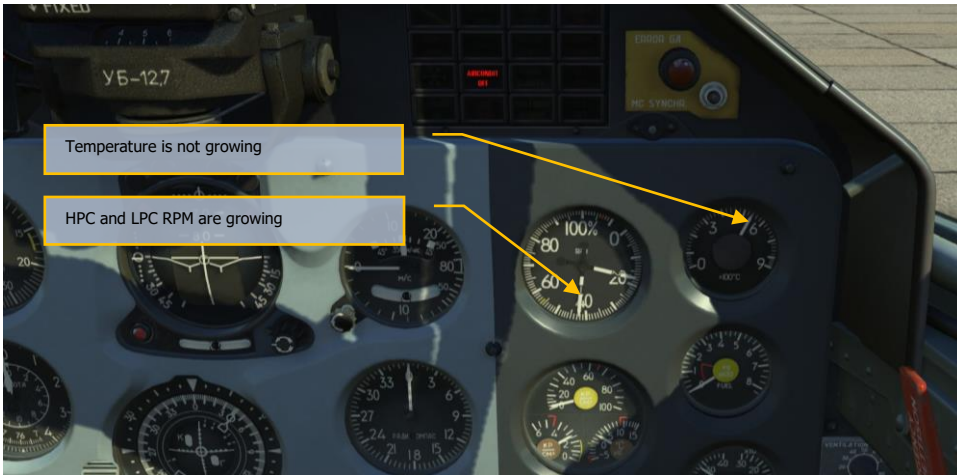

When engine operates at IDLE mode, check:

- HPC RPM should be within  $56 \pm 1,5\%$ .
- EGT should be not more than  $600^{\circ}\text{C}$ .
- Oil pressure is not less than  $2 \text{ kg/cm}^2$ , the ENG MIN. OIL PRESS is off.
- Engine start up time is not more than 50 sec.

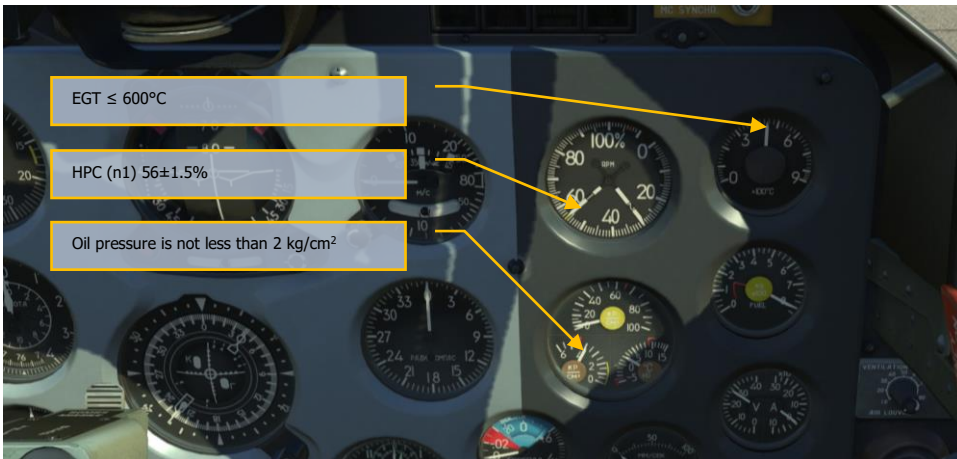

**NOTE: When HPC RPM reach 41,5—44,5% within 45 seconds, the Sapphire-5 APU automatically shuts off, air starter disconnects, TURBINE STARTER signal goes off, finishing starting cycle. Engine reaches Idle mode (HPC RPM within  $56 \pm 1,5\%$ ;) on its own.**

In case of unsuccessful engine start, perform cold rotation of the engine

For that set the STARTING – PRESERV. – COLD. ROTAT switch into COLD. ROTAT position.

In this case, ignition is disabled and starting and working fuel is not fed to engine.



STARTING-PRESERV. COLD ROTAT switch

Cold rotation is used to remove accumulated fuel from the combustion chamber.

During cold rotation throttle should be kept in STOP position.

- Press TURBO button for 1 – 2 seconds.
- When TURBINE STARTER signal flashes, press ENGINE button for 1 – 2 seconds.
- air starter spins up the HPC rotor within 45 seconds and automatically disables, turbine Starter switches to idle mode.
- Disable turbine starter by STOP TURBO switch.

STOP TURBO switch

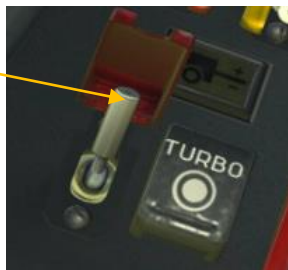

- When turbine starter is stopped return the STOP TURBO switch into initial position.
- Set the STARTING – PRESERV. – COLD. ROTAT switch back into STARTING position.
- Re-start the engine.

There is a possibility to do a false start, which is used for preservation and depreservation of fuel lines. During false start pilot performs the same actions as for normal start, except that STARTING – PRESERV. – COLD. ROTAT switch must be in PRESERV position. In this case ignition system is off, but all the starting units trigger in a normal (for engine start) sequence. This function is not implemented in simulator.

## After Engine Start

Enable:

- GENERATOR MAIN.
- GENERATOR EMERG.

If ground power was used for engine start, give command to disconnect ground power. [ \ ] (**radiomenu**), [F8], [F2], [F2] (**disconnect ground power**).

The GENERATOR and EMERGENCY GENERATOR and "Ground power connected" signals go off.

Check that voltage in onboard network is within 27-29V using voltmeter.



- **AGD-GMK.**
- **115V INVERTOR I, 115V INVERTOR II.**
- **RDO.**
- **MRP-RV.**
- **RSBN (Iskra).**
- **WING TANKS.**
- **Operation mode switch on the RLK-41 control panel has to be set to C AUT.**



- Give Close canopy command \*, [\] (radio menu), [F8], [F2], [F1] (Close canopy).
- When the canopy is closed, move canopy locks' lever to the far most position, ensure that cockpit is reliably closed and the CANOPY UNLOCKED signal is off.
- Seal the cockpit by moving cockpit pressurization and ECS lever all the way forward, after 30 seconds AIRCONDIT OFF signal goes off. Check pressure difference in the cockpit, read on UVPD (0,02-0,05).
- Set emergency brake lever to the far most position (parking brake).

**Note: canopy can be opened and closed by player by pressing: [LCtrl + C]**

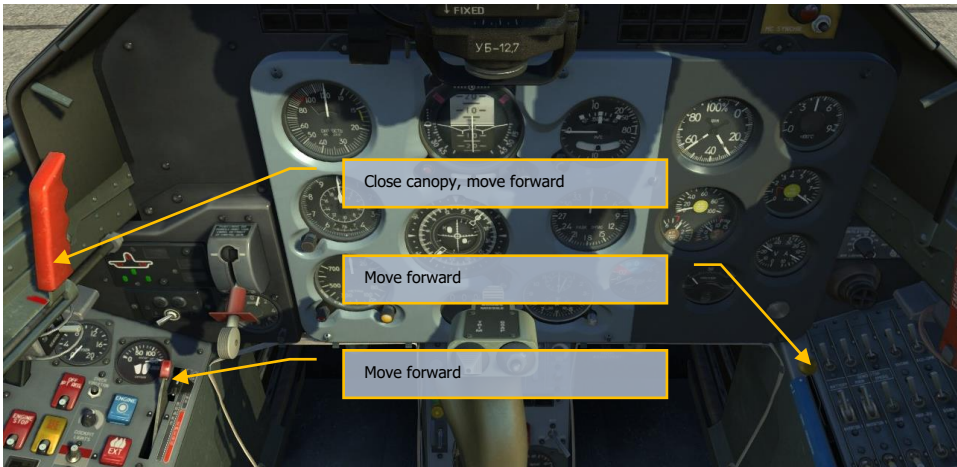

If ambient temperature is  $+5^{\circ}\text{C}$  or below, before the flight in adverse meteorological conditions and night flights, enable the PITOT TUBE HEATING MAIN and STAND-BY\_DE-ICING SIGNAL CB and set the ANTI-ICING switch into the AUTOMATIC position.

## Preparing For Taxiing And Taxiing

- Extend flaps at  $25^{\circ}$
- Press braking lever, hold it pressed and release parking brake.
- Give the "Remove wheel chocks" command to the ground crew;
- Make sure that wheel chocks were removed, look to the right, to the left and make sure that other airplane is not taxiing at the same time and if there are any obstacles on the way.
- Slowly increase engine RPM so that airplane begin to move. If the front wheel was turned at the start of movement, pilot has to stop turning using brakes.
- In a straight line taxi speed should not exceed 30 km/h without external stores, and 15 km/h with external stores. Before and during turn speed should not exceed 10 km/h.

Before taking a runway pilot must look around and make sure:

- if there are any obstacles on the runway;
- if there are other planes, planning landing or performing missed approach procedure.

Ask permission to take the runway, and when permission is received take the runway and roll 10-15 meters in a straight line to align front wheel with take-off direction. Brake wheels. Check that elevator

and aileron trimmers are in neutral position. Check if the RKL-41 ADF and the GMK-1AE compass show correct values (if necessary align it). Check that there are no warning signals except the DANGEROUS ALTITUDE.

Increase engine RPM to 90% and ask ATC permission to take-off.

## Circle Pattern Flight

**It used for practicing takeoff, turns, landing approaches and landing, as well as for visual landing approach on airfields without instrument landing system installed. Circle pattern altitude for standard landing approach is 600 meters. When landing on unknown airfield, pilot performs approach and landing using basic parameters.**

### Takeoff

When permission to takeoff is received, move the throttle all the way forward to the «TAKE OFF» (Takeoff) position, make sure that engine RPM reached takeoff value, release brakes and start takeoff run.

During the first phase of run airplane must be kept in a straight line with help of brakes, after 60 km/h by rudder. The stick should be in neutral position.

When speed reaches 150 km/h by smooth stick movement towards yourself lift the nose wheel to the takeoff position and keep this position until the airplane is airborne. If the wheel is lifted correctly, the horizon line will be aligned with gunsight pillow. At 180-190 km/h airplane smoothly detaches from the ground.

At height of 15 m and speed of not less than 220 km/h retract landing gear by setting the landing gear control lever in the upper position. Check if gear was retracted using L/G position indication panel (red lamps are on) and mechanical pointers (should be hidden in the wing).

### Climb

At altitude of 50 meters and speed of not less than 250 km/h retract flaps. Check flaps retraction using corresponding signal lamp (should be on), flaps retraction button has to return to its initial position.

**WARNING. At IAS of 310 km/h flaps retract automatically**

After flaps retraction, at altitude of 100 m, set engine RPM to 100% and continue climbing, increasing speed to 350 km/h.

## First And Second Turns

The first and second turns are performed together at heading opposite to the landing one.

At altitude of 300 m with bank angle of 20° at 350 km/h perform the first and second turns with climb.

50-70 m. before required altitude (600 m) start decreasing pitch and engine RPM to 90%, thus keeping constant speed of 350 km/h, remaining part of the turn perform horizontally at speed of 350 km/h and altitude of 600 m.

Exit from the second turn should be performed at heading opposite to the landing one, taking into account slip angle.

## Flight From Second To Third Turn

Up to the moment of gear extraction fly at speed of 350 km/h, height of 600 m with heading opposite to the landing one plus (minus) slip angle.

At abeam of RSBN (RSBN station bearing is 90° or 270°) check lateral distance using PPD-2, should be within 5.5 – 6 km.

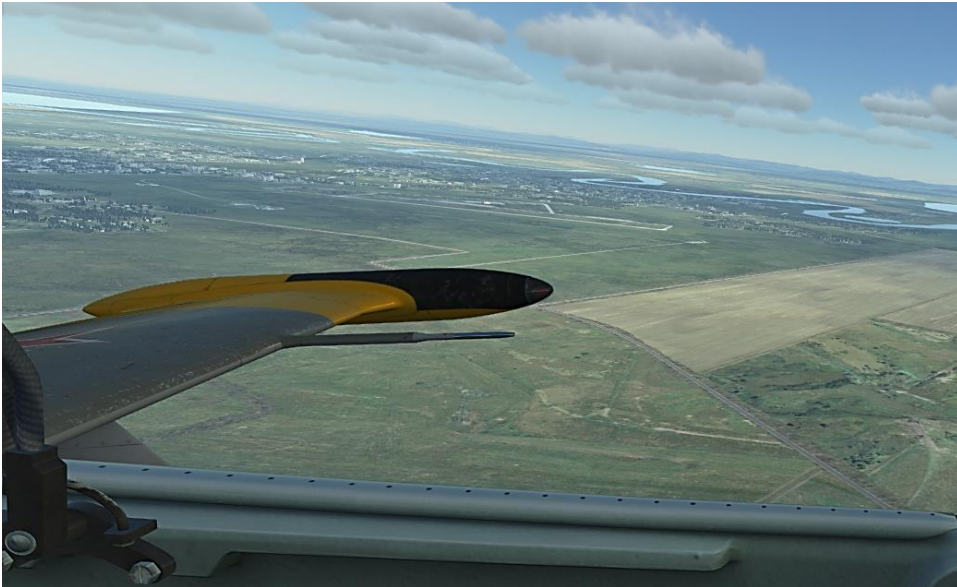

**Figure 141: Flight from second to third turn**



At abeam of runway threshold, set 80% RPM and reduce speed to 330 km/h, extend gear and make sure that gear are extended completely with help of lighting and mechanical signalization. After gear were extended set speed of 300 km/h (90% RPM).

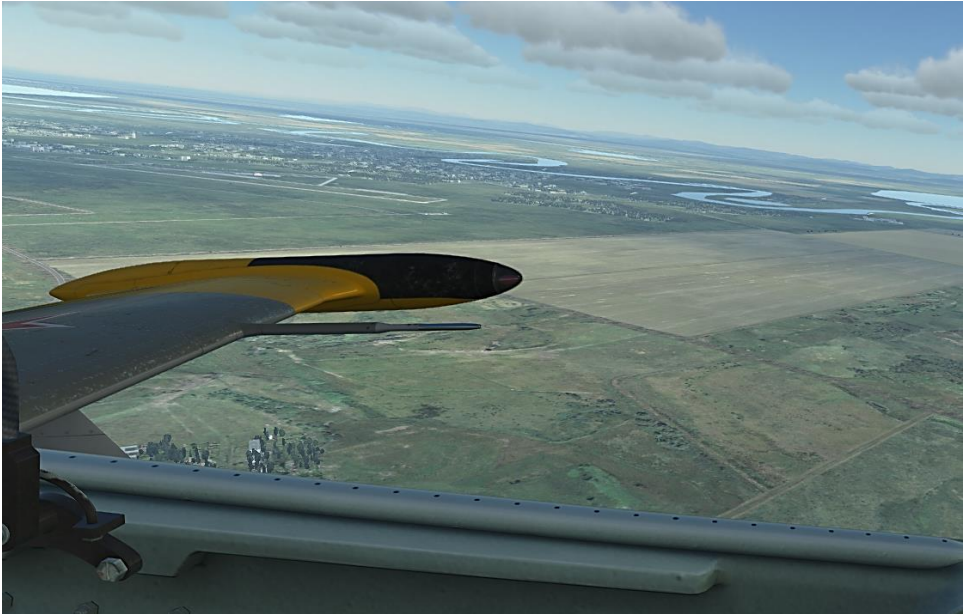

**Figure 142: At abeam of runway threshold**

## Third Turn

Third turn should be started after passing abeam of outer NDB, when NDB bearing is  $120^\circ$  ( $240^\circ$ ). It is a  $120^\circ$  turn, performed at 300 km/h with bank angle of  $30^\circ$ , before turn start set 92% RPM to keep required speed.

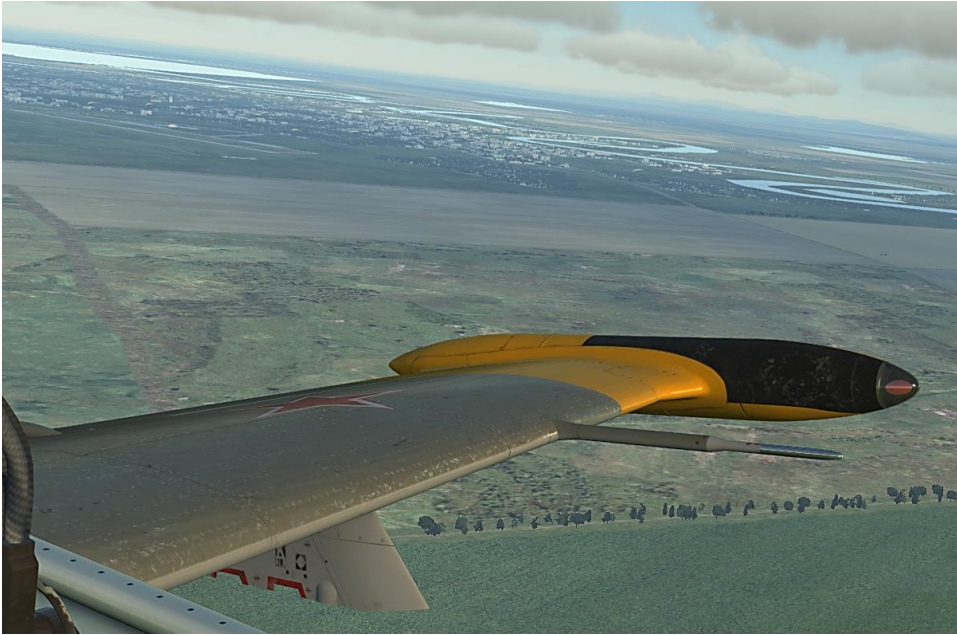

**Figure 143: Third turn**

Usually, place of the third turn is always the same and does not depend on wind speed and direction, if wind speed is less than 10 m/s. If wind speed is higher than 10 m/s, it is recommended to adjust the turn based on wind and perform the third turn earlier, taking into account airplane slip.

Perform exit from the third turn at NDB bearing of  $20^\circ$  ( $340^\circ$ ) towards fourth turn. Path of the airplane towards fourth turn should be  $65\text{-}70^\circ$  to runway centerline.

## Flight From Third To Fourth Turn

After third turn exit, reduce RPM to 85%, set speed of 280 km/h and extend flaps at  $25^\circ$ , start gliding with vertical speed of 4-5 m/s.

While gliding towards fourth turn, maintain direction to runway, keep speed of 280 km/h and vertical descent speed of 4-5 m/s, and monitor the altitude, estimating start of fourth turn.

Descent should be performed in such a way, that altitude before fourth turn entry was 400-420 m.

## Fourth Turn

Fourth turn should be started at the moment, when runway is seen at angle of  $15\text{-}20^\circ$ .



**Figure 144: Fourth turn**

Turn at speed of 280 km/h with 30° roll. Approach correctness during the turn should be corrected by roll adjustment.



**Figure 145: V=280 km/h, H=320 m**

After fourth turn exit airplane should lay on the continuation of the runway centerline, at a distance of 5-5.5 km from its beginning, at an altitude of 320-330m.

While performing fourth turn, main attention should be paid to speed maintaining, landing approach correctness and exit altitude.

If during this turn airplane descends to 300 m, increase engine RPM (up to maximum) and perform remained part of turn horizontally (without further descent).

After fourth turn exit extend flaps at  $44^\circ$  and check if they were extended correctly. When flaps are extended, increase engine RPM to 90%.

Continue descend with vertical speed of 4-5 m/s so that airplane passes outer NDB at altitude of 260 m and speed of 260 km/h.



**Figure 146: V=260 km/h, H=260 m**

While gliding, ensure that runway is free, approach was carried out correctly, flaps and landing gear are extracted.

## Descending After Fourth Turn

Perform descending into the towards runway after passing outer NDB with gradual speed reduction, so that inner NDB is passed at altitude of 60-80 m and speed of 230 km/h.



**Figure 147: V=230 km/h, H=60 m**

Outer or inner NDB overfly moment is determined by audio signal and MARKER signal blinking.

Estimation precision should be defined by glide path direction relative to flaring point. With proper estimation airplane descends towards flaring point, located 50-70 m from the beginning of the runway.

Underfly is fixed by pulling, for that RPM should be increased so that airplane maintains speed and descends towards flaring point with constant pitch angle.

Small overfly is fixed by reducing engine RPM. If approach is performed with overfly which cannot be fixed by RPM reduction, perform missed approach procedure.

## Landing

From 50 m ensure that approach estimation was correct, airplane is aligned with runway centerline and there are no obstacles on the runway.

At altitude of 30 m, check gliding speed, should be 230 km/h and move line of sight to the ground, forward in the direction of descent and to the left at 10-15°.



**Figure 148:** V=230 km/h, H=30 m

At altitude of 8-10m by smoothly pulling the stick start flaring with such a descending rate that airplane flares at altitude of 1m. At the end of flaring gradually reduce engine RPM.



**Figure 149:** Flaring

During flaring, line of sight should slide over the ground, approximately 35-40 m in front of the airplane and 15–20° to the left from airplane centerline. At the end of flaring ensure that it was finished at normal altitude.

While airplane descends towards the ground by pulling the stick create landing angle so that airplanes lands on two main wheels without parachuting. Airplane lands at speed of 180 km/h

After front wheel touched the ground start braking by pressing smoothly the brake lever, pedals are in neutral position.

After landing run leave the runway, retract flaps and taxi to the parking place.

## Crosswind Takeoff And Landing

When crosswind is up to 5 m/s, takeoff and landing technique is not harder than one without wind. When crosswind is more than 5 m/s, takeoff and landing technique has some peculiarities and require special attention.

During takeoff run banking effect due to cross wind need to be compensated by deflecting the stick into the wind. As the speed increases, aileron efficiency increases as well, therefore stick should be slowly returned to neutral position. Tendency of airplane to turn into the wind should be compensated by brakes during initial phase of takeoff run and later by rudder.

After gear and flaps retraction airplane slip has to be compensated by adjusting desired heading at value equal to slip angle.

During landing gliding slip has to be compensated by adjusting desired heading at value equal to slip angle.

Flaring should be performed in a normal way, by not adjusting heading. Before touch by deflecting pedals align airplane with runway axis. After touch down, lower the nose gear, by deflecting the stick into the wind compensate banking due to cross wind and by deflecting the pedals compensate tendency of the airplane to turn into the wind.

## Engine Shutoff

When arrived at parking place:

- Set the throttle to idle mode
- Move the cockpit pressurization and ECS handle all the way back
- Set operating mode switch on the RKL-41 control panel set to the **OFF** position
- Disable all the CBs, leave only **ENGINE CB**, **BATTERY** and **FLT RECORDER** switches enabled
- Set throttle to the STOP position
- Open canopy locks
- Give command Open Canopy to the ground crew
- When engine RPM pointers reached scale zero, disable all remaining CBs on the main CB panel and disable the **FLT RECORDER** switch

# Circle Pattern Flight

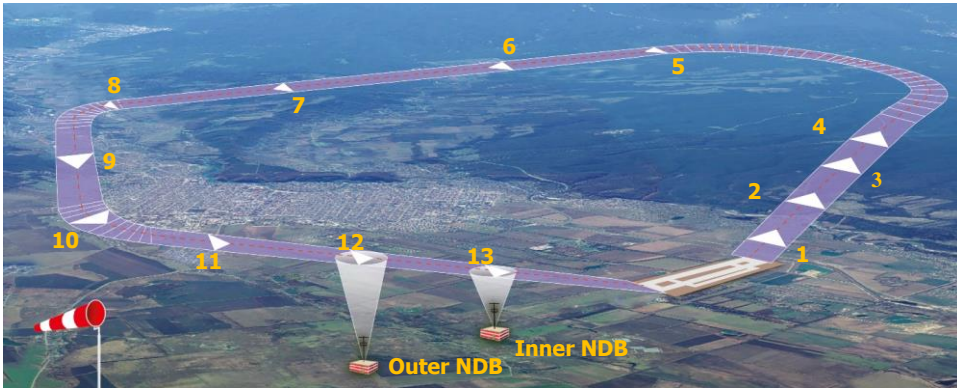

**Figure 150: Circle pattern flight**

1. H = 20 m. V = 250 km/h. – retract landing gear.
2. H = 50 – 70 m. V = 280 km/h. – retract flaps.
3. V = 300 km/h.  $n_1 = 100\%$ .
4. H = 300 m. V = 350 km/h. roll =  $20^\circ$  - turn entry at downwind leg.
5. H = 600 m. V = 350 km/h. Course =  $\text{Course}_{\text{downwind leg}} + \text{SA}$ .
6. H = 600 m. V = 350 km/h. abeam of the RSBN beacon. Beacon bearing =  $270^\circ$  ( $90^\circ$ ) PPD = 5,5 – 6 km.
7. Abeam of the runway threshold,  $n_1 = 80\%$ . V = 300 km/h. – extend gears.
8. H = 600 m. V = 300 km/h. Beacon bearing =  $240^\circ$  ( $120^\circ$ ), roll =  $30^\circ$  – third turn entry.
9.  $n_1 = 85\%$ . V = 280 km/h. extend flaps at  $25^\circ$ , beginning of glide with  $V_y = 4 - 5$  m/s.
10. H = 420 – 400 m. V = 280 km/h. Roll =  $30^\circ$  - fourth turn entry.
11. H = 330 – 320 m. – fourth turn exit, extend flaps at  $44^\circ$ .
12. H = 260 m. V = 260 km/h. – fly over outer NDB.
13. H = 60 – 80 m. V = 230 km/h. – fly over inner NDB.



# Aerobatics

## General Information

At all altitudes minimum allowed speed is 200 km/h, at this speed airplane is sufficiently stable and controllable.

If negative or near-zero Gs are created during flight the following signals DON'T START, 150 KG FUEL, ENG. MIN. OIL PRESS can go on and fuel meter can show false value. In these cases flight can be continued.

Inverted flight is allowed for not more than 20 seconds, oil pressure can drop below 2 kg/cm<sup>2</sup>.

Consecutive inverted flight can be performed after not less than 20 seconds horizontal flight (this time is needed to refill fuel accumulator) and only after oil pressure in engine was restored to normal value, which is 3 kg/cm<sup>2</sup> at 95% HPC RPM and not less than 2kg/cm<sup>2</sup> for other operating modes.

To prevent airplane stalling during aerobatics pilot must maintain G-factor which for altitude of 4000 m are:

IAS. km/h	$n_y$	IAS. km/h	$n_y$
200	1,25	400, 500	4,0 5,0
300	2,5	600	6,0

If shaking appears, pilot must immediately push the stick forward until shaking is finished, at the same time paying special attention to engine gauges (EGT and engine RPM).

During aerobatics pilot has to avoid flying with IAS less than 200 km/h. This especially important during performing of vertical aerobatics figures. In case of speed less than 200 km/h avoid over pulling the control stick, use coordinated movements.

To accelerate entry into aerobatic figures acceleration and braking of airplane should be performed not in horizontal level flight, but with descend or climb correspondingly. For intensive braking use air brakes.

To accelerate faster for the next ascending aerobatic figure pilot must keep engine RPM of not less than 90% on descending part of previous figure (second half-loop of inside loop, etc).

Start increasing engine RPM at dive angle of  $80 - 70^\circ$  so that next aerobatic figure entry would started from horizontal level flight, when reached required speed with engine RPM from nominal to takeoff value.

Vertical aerobatic figures (loop, half-loop) are not allowed at altitudes higher than 6000 m, because required entry speed exceeds Mach limitation.

To check correctness of aerobatic figures (especially during bad visibility of natural horizon) rely on ADI, which together with T/S indicator allows:

- Precisely controlling required bank and pitch angles (dive and climb) and monitoring them during aerobatic figures performing
- Controlling coordination between the control stick and pedals during figure entry, performing and exit
- Determining airplane position relative to natural horizon

## Behavior of the Airplane at Minimum Speeds

Minimum IAS (stall speed with G-factor equal to 1) with retracted flaps and gears, while engine is operating at idle mode is equal to 180 km/h, with retracted flaps and gear  $25^\circ$  ( $44^\circ$ ) – 160 (155) km/h.

With increase of the G-factor stall occurs earlier, i.e. at higher speeds.

When airplane reaches a speed which is 5-10 km/h higher than minimum one, warning shaking of the airplane and stick twitching (from ailerons) occur.

Following speed reduction is accompanied by shaking increase and appearing of roll fluctuations. When speed of 160-165 km/h reached and stick is pulled all the way back, airplane normally lowers nose and enters parachuting mode with gradual speed increase to 200-220 km/h.

Stall of the wing occurs less often with smooth stalling to the right in the most occasions. In these cases pushing the stick behind neutral position (ailerons in neutral position) increases the speed and airplane return in controllable flight. Ailerons are efficient up to the stall moment.

Pedals deflection during stalling can lead to a spin, which can have the same with pushed pedal direction of spinning or opposite one.

## Spin

The airplane can unintentionally stall into a spin only due to rough errors in piloting technique, related to excessive longitudinal stick deflections with non-coordinated pedals deflections for more than half way from their neutral position.

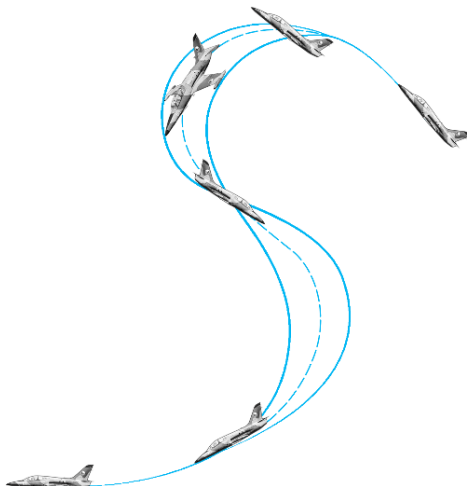

**Figure 151: Spin**

Altitude loss for 1 spinning turn is equal to 300- 400 m, time of one complete turn is 6-7 seconds. Total altitude loss from the moment airplane entered a spin to the returning into horizontal flight is about 500-650 m. Total altitude loss for 2 and 3 spin turns is correspondingly 1050-1200 and 1400-1700 m.

## Normal Spin

To intentionally enter a spin pilot has to follow this sequence:

Set speed of 300 km/h during horizontal level flight at altitude of 5000 m:

- Transition to climb with attitude of 20 degrees nose up and set throttle to IDLE.
- At speed of 190—180 km/h apply full rudder in the direction of spin; maintain the aircraft nose pointed at the horizon by smooth aft stick movements. At bank angle of 45 degrees apply full aft stick. At this point speed reaches 170—160 km/h. Ailerons should remain in neutral position during spin entry process.

Exit from a spin:

- deflect opposite to a spin pedal completely, and after that return stick to the neutral position or little bit further than neutral position

- when spinning is stopped, return pedals in neutral position and when speed reached 400 km/h, increase engine RPM to the takeoff value and exit from the dive with G-factor of 2.5 -3G

Exit from an unintentionally entered spin should be performed in the following sequence:

- estimate altitude
- identify the direction of spinning (ground surface moves from the right or from the left);
- set throttle to the «IDLE» mode
- set controls as if you wanted to enter spin intentionally, i.e. deflect pedal in the direction of spinning and stick all the way back (ailerons in neutral positions)
- deflect opposite to a spin pedal completely, and after that return the stick to the neutral position or little bit further than neutral position
- when spinning is stopped, return pedals in neutral position and when speed reached 400 km/h, increase engine RPM to the takeoff value and exit from the dive with G-factor of 2.5 -3G

**WARNING: If airplane does not exit a spin before 1500 m of altitude – pilots must eject!**

## Use of RSBN-5S (“ISKRA-K”) Equipment for Flight and Navigation

Before flying with help of RSBN-5S (“Iskra-K”) equipment the navigation and landing channel numbers have to be set from the front cockpit.

### NAVIG (NAVIGATION) MODE

The “НАВИГАЦИЯ” (Navigation) mode is a primary RSBN-5S (Iskra-K) mode.

Heading of the airplane is read on RMI’s internal scale against pointer with circle. Distance is read on PPD-2 gauge. Using heading and distance at any time of the flight, the airplane position relative to the airfield, navigation channel of which is selected, can be determined.

To quickly determine the bearing of the airport the sharp end of the RMI pointer is used. This pointer as well as the RKL-41 pointer, shows direction of flight to the airfield.

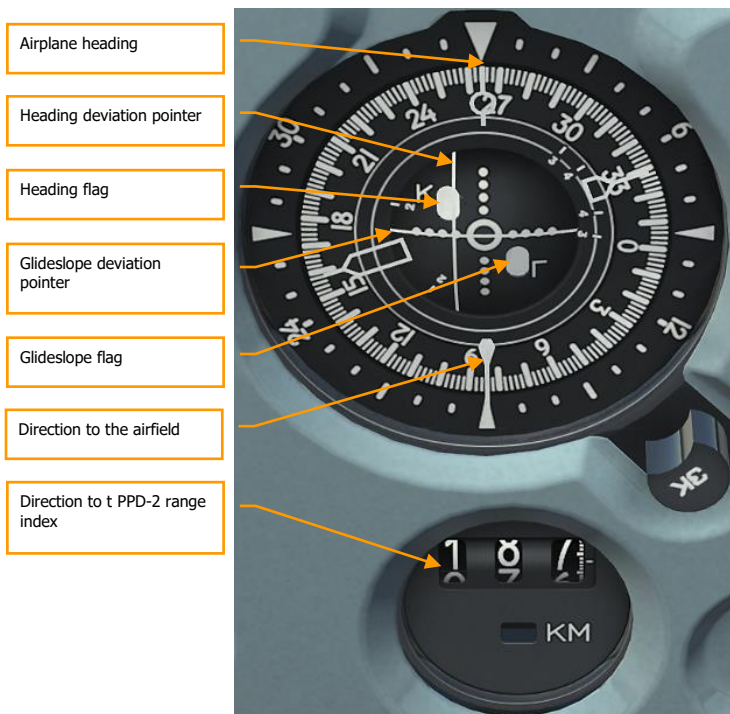

**Figure 152: RMI**

In the NAVIG mode, flight with required azimuth can be performed.

To flight from RSBN beacon:

- Using course knob set heading equal to required azimuth
- While flying from the beacon the distance on PPD-2 is increasing

To flight towards RSBN beacon:

- Using course knob set heading opposite ( $180^\circ$ ) to required azimuth
- While flying towards beacon the distance on PPD-2 is decreasing

To flight with required azimuth (required path) pilot must keep heading deviation pointer within central circle on RMI.

# Initial Approach and Landing Using RSBN-5S (Iskra-K) Equipment

In the L-39C simulator the following airfields Krasnodar-Central, Maykop, Krymsk and Mozdok have RSBN beacons together with instrumental landing system equipment (russian: PRMG), consisting of course beacons and glideslope beacons. Instrumental landing system on the Krasnodar-Central airfield is installed only on landing course of  $86^\circ$  and in Maykop on landing course of  $40^\circ$ .

Krymsk and Mozdok airfield have PRMG equipment for landing from both directions.

Pilots must know position of a RSBN beacon and take it into account while approaching airfield and performing landing approach. One must remember that landing course depends on wind direction set in the mission editor.

To ease navigation during airfield approaching and landing approach the airfield area can be represented in the form of two imaginary sectors.

Sector "A" when approaching with landing course, or with courses that differ from landing one for not more than  $\pm 15^\circ$ .

Sector "B" when approaching from other directions.

When mission is completed is necessary to:

- Turn the airplane towards RSBN beacon
- Find out in which sector is the airplane relative to the landing airfield (as help for airplane position determination, use F10 button)
- Flight to the airfield

If decision to land on an airfield other than departure airfield was taken, pilot must:

- Set new landing heading using course knob
- On the RSBN control panel set new navigation and landing channels
- Make sure that RMI and PPD-2 indicate heading and distance relative to selected airfield and lamps AZIMUTH/DISTANCE CORRECTION and signals AZIMUTH CORRECT and DISTANCE CORRECT are on
- Set airfield atmospheric pressure on ZDV-30.
- Set outer and inner NDB (arrival airfield) frequencies, RKL-41 pointer should show bearing to outer NDB
- Turn towards RSBN beacon
- Find out in which sector is the airplane relative to arrival airfield
- Approach airfield

## The airplane is in "A" sector

If the airplane flies at altitude of 5000 -8000 m and distance of 50-132 km, it is advisable to use the GLIDE PATH mode. If distance is 12 – 30 km, and altitude is 600 – 1500 m, use the LANDING mode.

The **GLIDE PATH** mode is used to assist navigation towards arrival airfield with descent to safe altitude, equal to 600 m, at any required RSBN **bearing** or at **landing course**.

Descending mode is determined by cloud penetration trajectory lying in vertical surface at angle of 4–5° relative to horizon. Glide path trajectory is within 132-21 km.

At distances higher than 132 ±5 km, glideslope deviation pointer shows airplane position relative to cruise altitude, which is equal to 8000 m.

At distances from 132±5 to 21 ±3 km. glideslope deviation pointer shows airplane position relative to cloud penetration trajectory.

At distances of less than 21 ±3 km glideslope deviation pointer shows position of the airplane relative to safe altitude, equal to 600 m.

When distance of 21±3 km is reached, then in front and rear cockpits, the END OF DESCENT signal will be on and glideslope deviation pointer show airplane position relative to altitude of 600 m. To follow glideslope descent trajectory engage the LANDING mode.

For flying in glide path mode is necessary:

- Check is course pointer is set to landing course
- LANDING- NAVIG- GLIDE PATH mode selector switch set to GLIDE PATH
- Set airfield atmospheric pressure on ZDV-30.
- Course deviation pointer on RMI and ADI bank steering pointer show airplane position relative to RSBN beacon
- Glideslope deviation pointer on RMI and pitch steering pointer on ADI show airplane position relative to glide path trajectory
- PPD-2 indicates distance to RSBN beacon

**NOTE: Glideslope and course deviation pointers on RMI and pitch and bank steering pointers on ADI duplicate each other. To ease piloting it is advisable to concentrate attention on RMI pointers only. It is also necessary to monitor speed and altitude. Speed at glide path trajectory should be within 400 -500 km/h.**

- Perform horizontal and vertical maneuvers to align course and glideslope deviation pointers with central circle.
- Circle in the center of RMI gauge symbolize the airplane. To follow the cloud penetration trajectory glideslope and course deviation pointers must be kept within this circle;
- When airplane is below cloud penetration trajectory, vertical maneuver can be omitted, Because in horizontal level flight the airplane gradually approach penetration trajectory and

glideslope deviation pointer moves from the uppermost position on RMI towards central circle.

- When distance of  $21 \pm 3$  km is reached, then in front and rear cockpits, the END OF DESCENT (Cloud penetration is finished) signal will be on and glideslope deviation pointer show airplane position relative to altitude of 600 m, set speed of 350 km/h
- To follow radio glideslope set the LANDING- NAVIG- GLIDE PATH mode selector switch in LANDING position

**Important: For correct use of the LANDING course pointer on RMI should be set to landing course of the arrival airfield.**

LANDING mode engaging:

- Glideslope deviation pointer moves up
- Glideslope and course warning flags are off
- PPD-2 indicates distance to glideslope radio beacon

Final approach descending:

- Continue horizontal level flight at altitude of 600 m
- Turn the airplane towards heading deviation pointer on RMI
- $D=15$  km, reduce engine RPM to 80%, set speed of 330 km/h, extend gear.
- Keep reducing speed to 280 km/h and extend flaps at  $25^\circ$
- Increase engine RPM to 90% and maintain speed of 280 km/h and altitude of 600 m
- While approaching radio glideslope ( $D=12$  km) glideslope deviation pointer will be moving towards central circle on RMI
- $D=12$  km, altitude – 600 m, radio glideslope descent start, keep glideslope and course deviation pointers within RMI's central circle, maintain speed of 280 km/h,  $V_y - 3 - 4$  m/s
- $D= 6$  km, corresponds to altitude of 300 m, extend flaps at  $44^\circ$ , maintain speed of 260 km/h
- Keep descending following the radio glideslope by keeping glideslope and course deviation pointers within RMI's central circle, maintain speed of 260 km/h
- Fly over outer NDB, speed – 260 km/h, altitude – 200 m, overfly of outer NDB moment is marked by audio signal and MARKER signal lamp blinking
- After passing outer NDB control speed reduction so that over inner NDB speed was not less than 230 km/h
- Fly over inner NDB at  $H=80-60$  m and speed of 230 km/h, overfly of inner NDB moment is marked by audio signal and MARKER signal lamp blinking
- After passing inner NDB establish visual contact with the runway, estimate airplane position relative to the runway and land



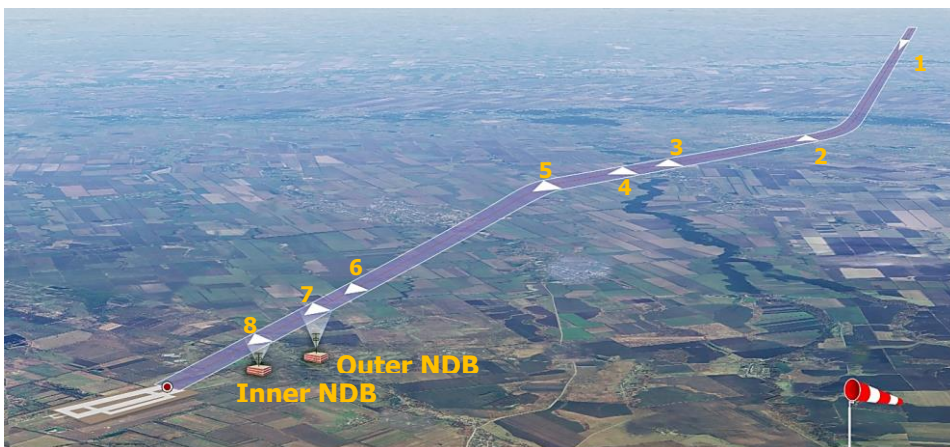

**Figure 153: Landing pattern using GLIDE PATH and LANDING modes**

1. Descent in cloud penetration mode;
2. Altitude - 600 m. D= 21±3 km. end of «GLIDE PATH» mode;
3. Altitude - 600 m. D = 15 km. speed - 330 km/h – extend gear;
4. Speed - 280 km/h – extend flaps at 25°.
5. Altitude - 600 m. D = 12 km. Radio glideslope entry point.
6. Altitude - 300 m. D = 6 km. speed - 280 km/h – extend flaps at 44°.
7. Fly over outer NDB, speed - 260 km/h, altitude - 200 m.
8. Fly over inner NDB, speed - 230 km/h, altitude - 60 – 80 m.

The L-39C airplane is equipped with the SDU system, which significantly ease landing approach. When course beacon signal is captured, enable the SDU CB and SDU switch. "Т" и "К" warning flags will be off on ADI.

The following flight perform following the steering pointers (bank and pitch) on the ADI. If the pointers are kept in the center the airplane descends following requires glideslope. Distance to glideslope beacon is indicated on PPD-2.

## The airplane is in the "B" sector

If after performing task you flew far away, it is necessary to perform final leg entry at distance of 15-21 km, according to PPD-2 (as a help for determining heading map can be used (key F10)). When approaching final leg entry set the altitude of 600 m, speed of 350 km/h and perform final leg turn. Before final turn engage the LANDING mode. Final approach descending is described above.

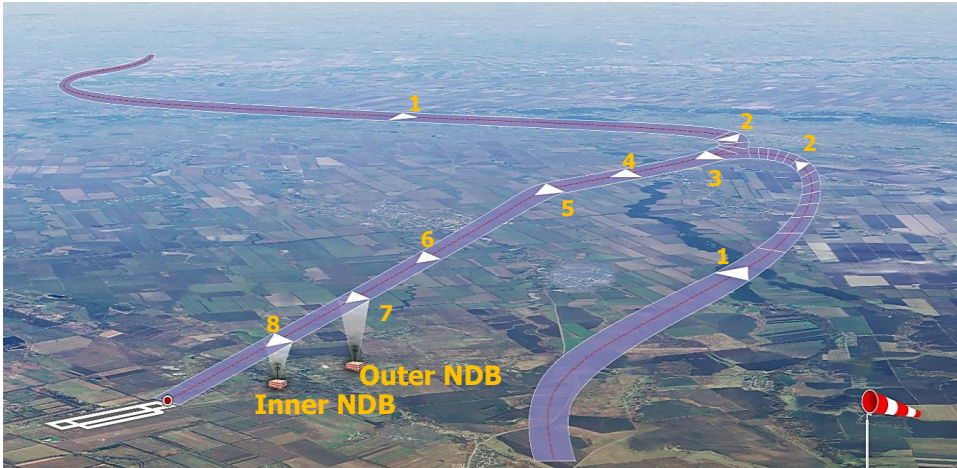

**Figure 154: Scheme of airfield approaching and landing approach using LANDING mode**

1. Initial approach
2. Base turn, engaging «LANDING» mode
3. Altitude - 600 m. D = 15 km. speed - 330 km/h – extend gear
4. Speed - 280 km/h – extend flaps at 25°
5. Altitude - 600 m. D = 12 km. Radio glideslope entry point
6. Altitude - 300 m. D = 6 km. speed - 280 km/h – extend flaps at 44°
7. Fly over outer NDB, speed - 260 km/h, altitude - 200 m
8. Fly over inner NDB, speed - 230 km/h, altitude - 60 – 80 m

## Approaching Airfield Using RKL-41

If the airfield is not equipped with RSBN and PRMG, then RKL-41 should be used for approaching.

- Using course knob on RMI set the landing course
- Set outer and inner NBD frequencies
- Ensure that RKL-41 pointer points towards the outer NDB
- Using together RMI, RKL-41, map (F10) determine position of the airplane relative to airfield, turn the airplane towards the airfield
- For early runway detection it is advisable fly at altitudes of 1000-2000m
- After visual detection of the runway, maneuver the airplane in such a way that it flies over the outer beacon with course equal to landing one

- Descend to the altitude of 600 m, while descending set speed of 350 km/h, prepare to the first turn
- Follow the circle pattern for landing

Take into account that during approach and landing with RKL-41, distance on the PPD-2 is not indicated.

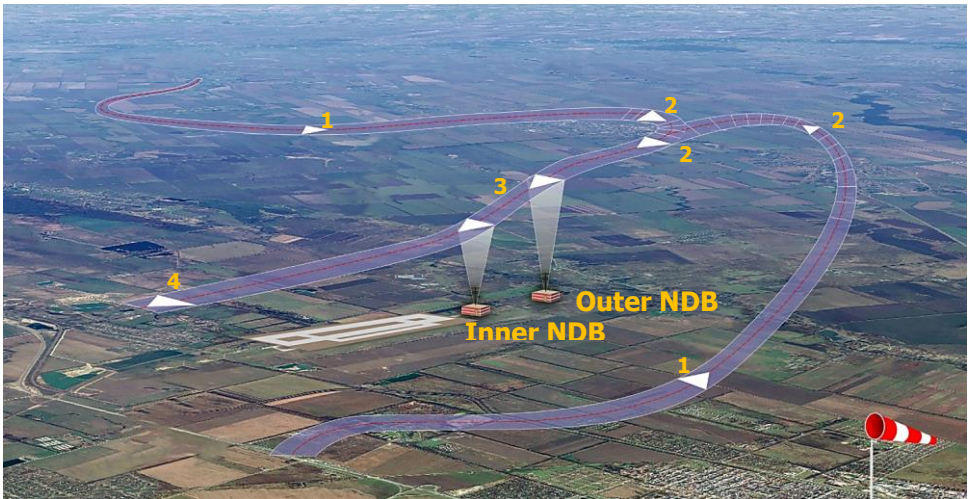

**Figure 155: Landing scheme with help of RKL-41**

1. Airfield approaching
2. Alignment with runway direction using outer NDB beacon
3. Descend to altitude of 600 m
4. First turn

# COMBAT EMPLOYMENT



# COMBAT EMPLOYMENT

## Aircraft Armament

The L-39C airplane has bomb and missile armament. It has the ASP-3NMU-39 gunsight, FKP-2-2 gun camera and EKSR-46 auxiliary armament.

Armament, gunsight and photo control equipment of the L-39C are used for the following tasks:

- Accurate dive bombing with 50 - 100 kg bombs
- Accurate S-5 rocket shooting at ground target during diving
- Shooting R-3S at aerial targets

Weapon controls are concentrated on the center panel in front cockpit. Combat button is located on the stick in the front cockpit only.

## Bomb Armament

Bomb armament consists of:

- L-39M-117, L-39M -118 wing pylons
- Two bombs
- Bomb release control system

Bombs are attached to wing pylons.

With help of combat release system only armed bombs (single or salvo) can be released when speed of the airplane is higher than 310 km/h (when speed is below 310 km/h – combat system is blocked.) In case of emergency release all bombs are released simultaneously.

Bomb armament controls and signalization in front cockpit

- ARMS CB – electrically supplies combat button
- PORT –STARB. BOTH double-position switch is used for selecting bombs release mode. For consequent release set this switch first to the «PORT», and then to the «STARB. BOTH» position. If set to the «STARB. BOTH» two bombs will be released simultaneously.
- EMERG. JETTIS. switch is used for emergency jettison the stores
- LIVE-BLANK switch is used for arming bombs when they to be released by the emergency bomb release system
- EXPLOSIVE signal indicating that «LIVE-BLANK» CB is in «LIVE» position

- Stores are present signals indicating that bombs are attached
- STAND ALERT signal, indicating that armament control system is ready. This signal is on when speed is higher than 310 km/h
- Combat trigger safety cover

Bomb armament controls and signalization in rear cockpit:

- ARMS CB - supplies armament control system
- EMERG. JETTIS. switch is used for emergency jettison the stores. This switch must be in neutral position
- LIVE – BLANK switch is used for arming bombs when they to be released by the emergency bomb release system. This switch must be in neutral position

**Note: This switch is a command one to that of in front cockpit. If switch is set to LIVE or BLANK, bombs will be dropped in explode or non-explode mode, independently of switch position in front cockpit**

- Stores are present signals
- ARMAMENT FIRE indicates that combat trigger is pressed in the front cockpit
- STAND ALERT signal
- EXPLOSIVE signal

## Unguided Weapon

Unguided weapon consist of:

- two UB-16-57U universal launchers;
- 32 rockets of S-5 type;
- PUS-36DM firing control device;
- L-39M-117, L-39M -118 wing pylons;
- fire control and signalization electrical system.

UB-16-57U universal launchers are attached to the wing pylons. PUS-36DM sends and distributes electrical pulses between rockets' electrical ignitors in both launchers. Electrical control system allows rockets launching at speeds higher than 310 km/h (below 310 km/h this system is blocked) in the following sequences:

- 32 rockets in sequence (16 per launcher)
- 4 rockets in sequence (2 per launcher)
- 2 rockets in sequence (1 per launcher)

Unguided weapon controls and signalization in front cockpit:

- ARMS CB – electrically supplies combat button
- UB-16 CB – supplies PUS-36DM, UB-16 launchers, when the «UB-16» CB is enabled the PUS-0 signal goes on
- EMERG. JETTIS. switch is used for emergency jettison the stores
- 2RS – AUT. – 4RS (2 rockets –Auto – 4 rockets) switch selects rocket launch mode. «2RS» (2 rockets) – every time the combat trigger is pressed 2 rockets: 1 from the left and 1 from the right will be launched with 0.025 second delay. «4RS» (4 rockets) –every time trigger is pressed, 4 rockets will be launched (2 per launcher). «AUT» – all 32 rockets will be launched when the trigger is depressed.
- Stores are present signals indicating that bombs are attached
- STAND ALERT signal, indicating that armament control system is ready. This signal is on when speed is higher than 310 km/h.
- PUS – 0 signal, indicates that PUS-36DM is ready for firing. After first rockets were launched this signal goes off
- Combat trigger safety cover

Unguided weapon controls and signalization in rear cockpit

- ARMS CB - supplies armament control system
- EMERG. JETTIS. switch is used for emergency jettison the UB-16 blocks
- Stores are present
- ARMAMENT FIRE indicates that combat trigger is pressed in the front cockpit
- STAND ALERT signal

## Guided Missile Weapon

Guided rocket weapon consists of:

- two R-3S guided missiles
- two APU-13M1 missile launchers
- L-39M-117, L-39M -118 wing pylons
- MP-28A G-sensor
- R-3S missiles fire control, signalization and electric supply system

Guided missiles can be launched at speeds higher than 310 km/h.

APU-13M1 launchers are intended for R-3S missile mounting and power supply. Missile launchers are attached to wing pylons.

The MP-28A G-sensor is designed for measuring G-factor and signaling if it is higher than 2 units.

Guided weapon controls and signalization in front cockpit:

- ARMS CB – electrically supplies combat button
- HEAT SS – supplies missile seeker heating circuit and the ROCKETS HEATING signal in rear cockpit

- GLOW SS – supplies G-sensor, missile seeker glowing circuit and the GLOWING ON signal in rear cockpit
- EMERG. JETTIS. switch is used for emergency jettison the stores
- PORT – STARB. BOTH double-position switch is used for selecting missiles release mode. In contrast with bombs release modes, missiles can be launched only consequently one by one depending on position of the switch. Simultaneous launch is impossible.
- Stores are present signals indicating that APU launchers are attached
- VOLUME SS – volume knob, regulating missile heat seeker lock audial signal volume
- STAND ALERT signal, indicating that armament control system is ready. This signal is on when speed is higher than 310 km/h.
- NO LAUNCH signal indicates that allowed G-factor of more than 2 units is exceeded. Missile cannot be precisely pointed to the target.
- A-A MISSILE signals, indicating that missiles are attached to APU launchers
- Combat trigger safety cover

Guided weapon controls and signalization in rear cockpit:

- ARMS CB - supplies armament control system
- EMERG. JETTIS. switch is used for emergency jettison the stores
- Stores are present
- A-A MISSILE (SS) signals
- ARMAMENT FIRE indicates that combat trigger is pressed in the front cockpit
- STAND ALERT signal
- NO LAUNCH signal
- ROCKETS HEATING signal
- GLOWING ON signal
- EXPLOSIVE signal



# Armament Controls and Signalization in Front Cockpit

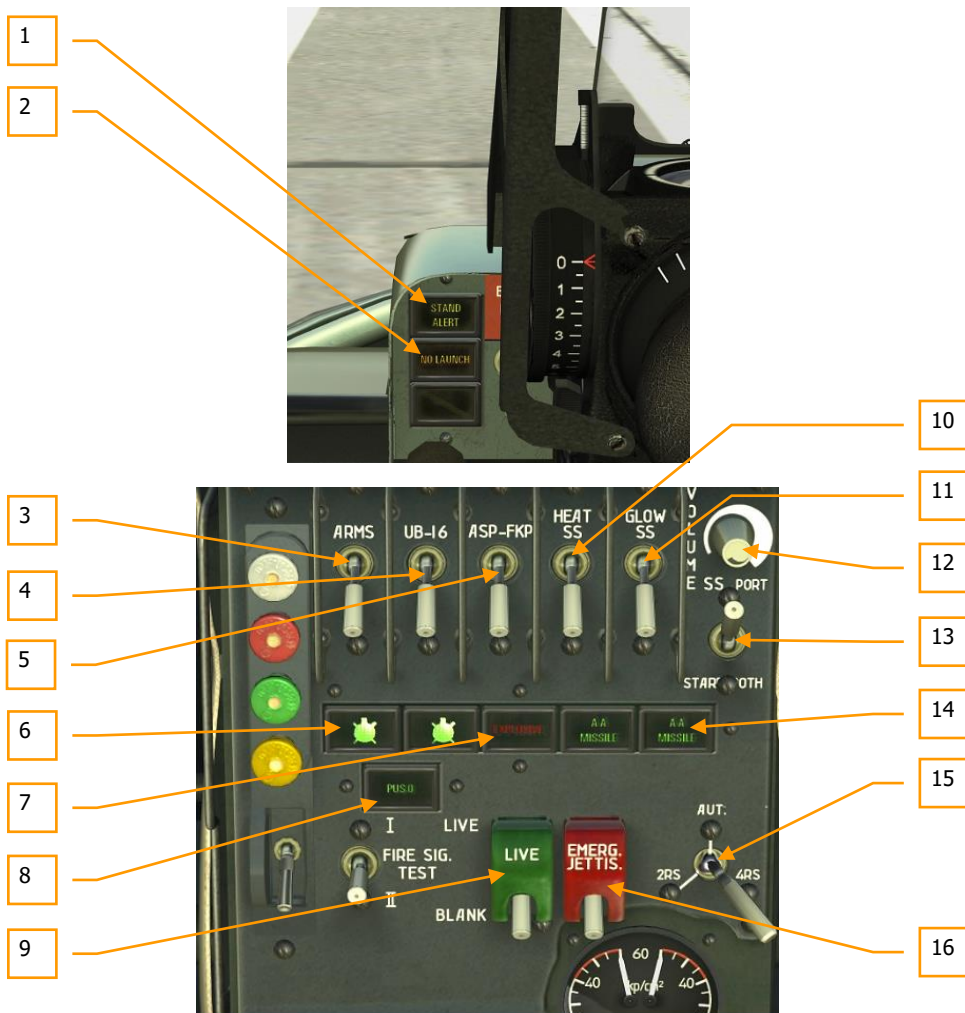

Figure 156: Armament controls and signalization in front cockpit





**Figure 157: Armament controls and signalization in rear cockpit**

- 1 ARMS CB
- 2 LIVE-BLANK switch
- 3 EMERG. JETTIS. switch
- 4 STAND ALERT
- 5 NO LAUNCH
- 6 EXPLOSIVE
- 7 Stores are present
- 8 A-A MISSILE
- 9 ARMAMENT FIRE
- 10 GLOWING ON
- 11 ROCKETS HEATING

## Aiming and Photo Equipment

Aiming equipment includes ASP-3NMU-39 gunsight.

Gunsight management is not difficult, but requires certain skills and attention.

Aiming basically consist of two simultaneous operations: keeping central dot of aiming grid over target by maneuvering the airplane.

Distance rheostat and optical rangefinder with external base form range finding device. Operation principle of the rangefinder is based on target size measurement depending on distance to the target. Only if target base is within 14 -22 m. rangefinder can provide gunsight with distance within full range of 180-800m. For targets with bases of less than 14 m. maximum distance cannot be entered into gunsight, and for targets with bases of more than 22 m. – minimum distance. This is explained by the fact that optical rangefinder’s grid diameter is limited by 17.5 mil (maximum distance) – 122 mil (minimum distance).

Gunsight has two operating modes: GYRO and FIXED. In the GYRO target leading angle is being calculated automatically during aiming. To use gunsight as collimator sight, the FIXED mode with fixed grid is used. Gunsight operation mode is selected by the switch on the gunsight.

To quickly change GYRO mode to the FIXED one, pilot must enter the minimum range in the gunsight by rotating distance grip on the stick, due to that circuit contacts closure occurs and aiming grid became fixed. To return back to GYRO - enter the maximum distance. There is a mechanical sight, which is a standby device and consists of a front sight and a ring with cross-hair. The gunsight has light filter and grid brightness adjustment knob.

The gunsight has rotative reflector. It allows deflection of the optical axis at angle of 0-20°, thus entering estimated correction for shooting and bombing.

Main parameters of the gunsight:

- Maximum target leading angle, calculated by the gunsight – not less than 8°
- Target distance which can be entered in the gunsight - 180-800 m.
- Target base, which can be entered in the gunsight- 7-45m
- Angular angle of the variable grid largest circle - 122 mil
- Angular angle of the variable grid smallest circle -17,5 mil
- Angular angle of the constant grid circle - 132 mil
- Angular angle of the mechanical sight 132 mil

For enabling gunsight enable the ASP-FKP CB on the center panel of front cockpit.

The photo control equipment includes FKP-2-2 gun camera, installed on the ASP-3NMU-39 aiming head and intended for checking aiming results.

FKP-2-2 main parameters:

- Maximum photographing range of target with size of 10m - 750-800m
- Maximum photographing range of target with size of 20m - 1300-1500m
- Continuous shooting duration - 12 seconds
- Number of frames - 60

For enabling gunsight enable the ASP-FKP (Gunsight- Gun camera switch) CB on the center panel in front cockpit. When combat trigger on the stick is pressed the gunsight grid is photographed. The guncamera operation is controlled by rotation of the disk on the unit case. Besides that device operability can be checked by pressing the FKP button on the stick in front cockpit.

Gun camera photos are shown during track playing.

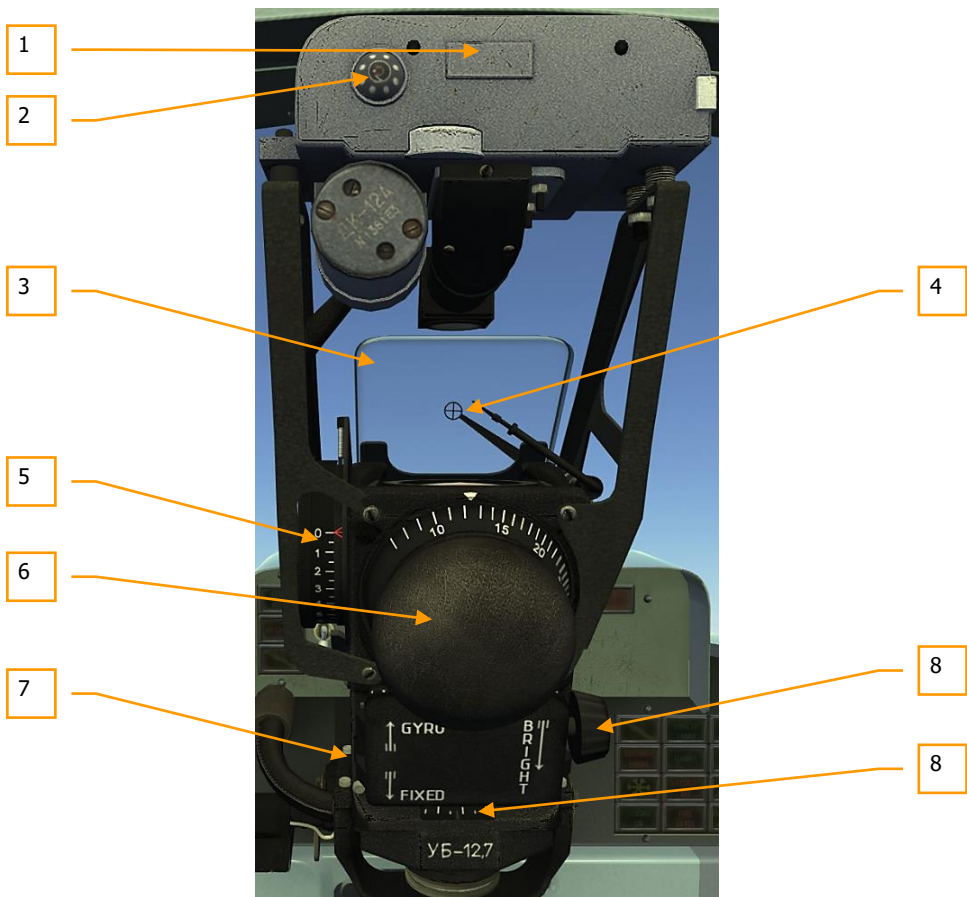

**Figure 158: ASP-3NMU gunsight and FKP-2-2 guncamera**

- 1 FKP
- 2 FKP operating control disk
- 3 Rotative gunsight reflector
- 4 Mechanical sight
- 5 Reflector deflection angle knob
- 6 Target base knob
- 7 GYRO– FIXED switch
- 8 Gunsight grid brightness knob
- 9 Rheostat and distance scale

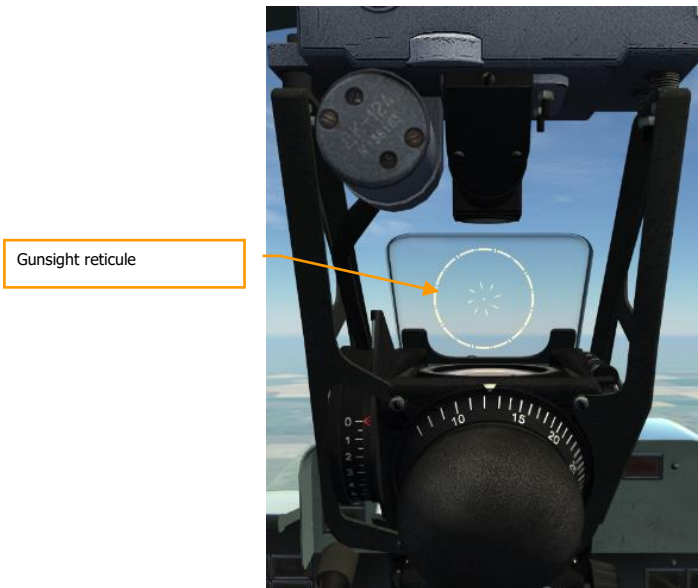

Figure 159: Gunsight reticle



Figure 160: Gunsight controls

1. Distance grip. By rotating this grip counterclockwise distance entered in the gunsight is reducing, clockwise – increasing
2. Combat trigger safety cover
3. FKP button

## ESKR-46 Signal Flares

ESKR-46 electrified signal flare cartridge is used for launching signal flares.

Flare launching system consist of PU-EKSR-46 firing control unit in the front cockpit and one four-barrel cartridge for 26-mm signal flares. Cartridge is installed on the right in the tail part of the fuselage.



**Figure 161: ESKR-46 Signal Flares**

For launching signal flares one must enable the ESKR-46 power switch and press the corresponding button.

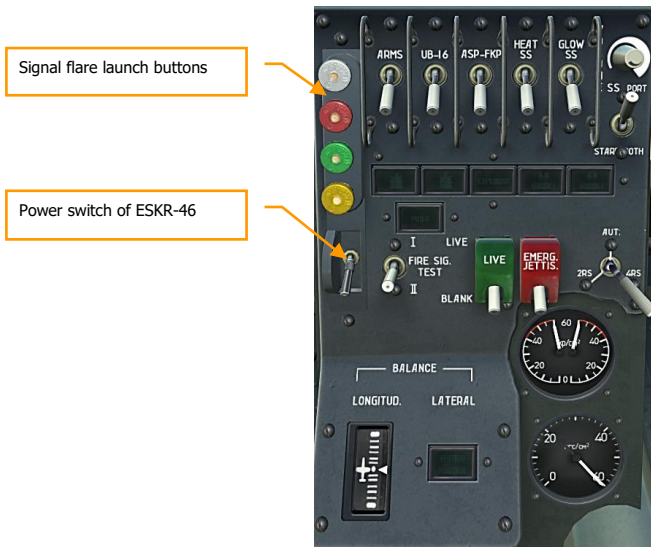

Figure 162: EKS-46 control panel



## Ground Target Engagement Pre-flight Preparation

Ground targets engagement flights are complex tasks, which require from pilot strong piloting skills and knowledge of aircraft armament operation.

Before flight examine the armament operation procedures, piloting technique, clarify aiming data (fictitious target base and reflector deflection angle).

### Fictitious target base calculation

Since the recommended shooting and bombing ranges exceed maximum distance (800 m) which can be entered into gunsight, fictitious target base should be entered for external base rangefinder to operate correctly. It is defined by the following equation:

$$B_f = B_a \times D_m / D_s$$

where:

- $B_f$  – fictitious target base, m;
- $B_a$  – actual target size, m;
- $D_m$  – maximum distance, entered into gunsight - 800 m;
- $D_s^*$  – shooting (bombing) distance.

$D_s^*$  - see Tables 1 and 2.

## Bombs Delivery

Before the flight, make sure that the NETW, ARMS and SIGNAL CBs are enabled in rear cockpit.

**Very important phase of dive bombing is arriving at point where turn and dive entry are performed. The accuracy of arriving at this point impacts on dive angle and release speed.**

Bombing should be performed at diving angles of 20, 30 и 40 under conditions listed in table 1 below.

Table 1

Nº	Parameters	20°	30°	40°
1	Gunsight reflector deflection angle	13°	11°	10°
2	Dive entry altitude at ingress point	1200 m	1500 m	1800 m
3	Dive entry speed at ingress point	440 km/h	350 km/h	300 km/h
4	Release altitude	730 m.	800 m	1100 m
5	Release speed	570 km/h.	550 km/h.	560 km/h
6	RPM	97%	92%	MG%

While approaching target:

1. Enable ASP-FKP CB [LShift+7].
2. Set the desired bombs release mode using the PORT- STARB. BOTH switch [RAlt+RCtrl+RShift+R].



3. Set gunsight reflector to angle corresponding to dive angle and raise the seat to the upper position [LShift+S] – raise the seat, [LAlt+LShift+S] – lower the seat] so that one could see the central dot of aiming grid and upper part of the rangefinding circle. Due to that, habitual view from the cockpit will change.
4. Set the fictitious target base.
5. GYRO-FIXED switch set in the FIXED position [LShift+J].

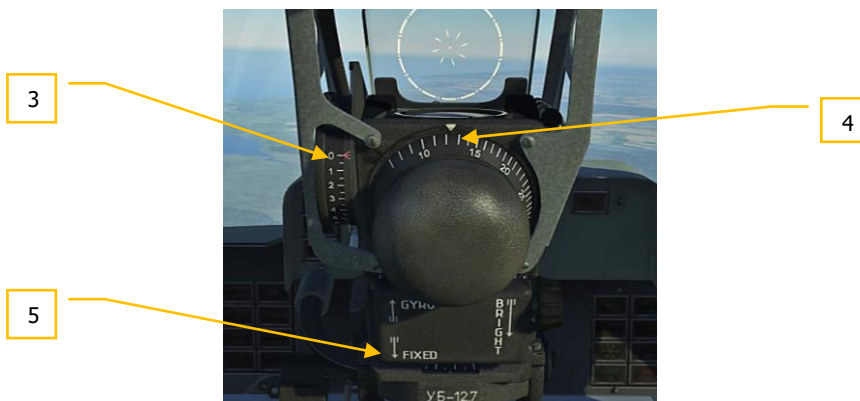

6. Enter minimum distance into gunsight [.,].



Actions in the target area:

1. Approach target required altitude of and at required speed (see Table 1).
2. Enable the ARMS CB [LShift + 5].

2



3. Ingress maneuver should be performed in such a way that target moved to the required target viewing angle (turn starting point).



4. At the moment when target reaches required viewing angle, start turning towards attack course with 60-120° roll and simultaneous dive entry.



5. Turn and dive entry should be finished in such a way that aiming grid center is under the target at distance equal to 1 radius of the constant diameter aiming circle.

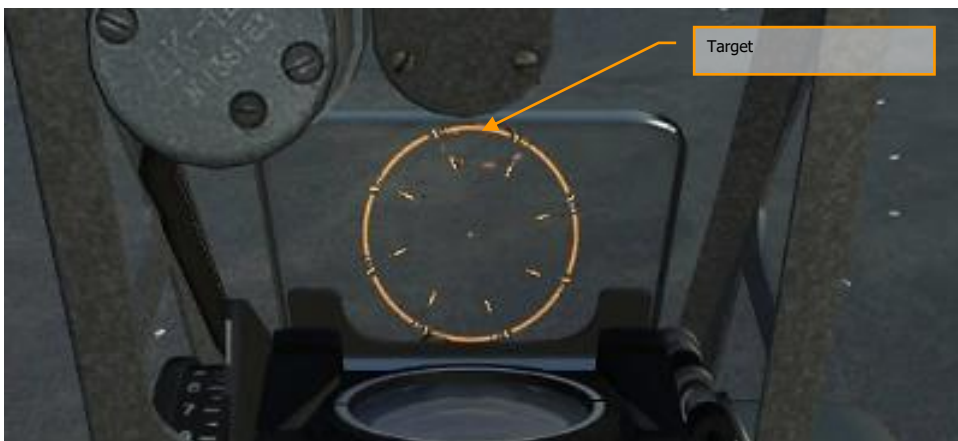

6. Flip the combat trigger down [LCtrl+Space], and while airplane is descending, the central dot of the aiming circle will be moving towards the target, speed and altitude - towards the required release values.
7. When required speed and altitude are reached and central dot is aligned with the target, press the combat trigger (1 second) [Space] and release the bombs.



8. Immediately after bombing exit from the dive with G-factor of 4-5 units, simultaneously increasing engine RPM to TAKE OFF.

## Unguided Rockets Delivery

Before the flight make sure that the NETW, ARMS and SIGNAL CBs are enabled in rear cockpit.

Unguided rockets should be fired at dive angles of 20 and 30° under conditions listed in the Table 2.

Table 2.

<b>Nº</b>	<b>Parameters</b>	<b>30°</b>	<b>20°</b>
1	Gunsight reflector deflection angle	2,53°	2,30°
2	Dive entry altitude at ingress point	1200 m.	1200 m
3	Dive entry speed at ingress point	300 km/h	400 km/h
4	Shooting altitude	600 m.	500 m.
5	Speed at shooting moment	550 km/h	560 km/h
6	Shooting distance	1200 m	1460 m

While approaching target:

1. Enable UB-16 CB [LShift + 6].
2. Enable the ASP-FKP CB [LShift+7].
3. Using the 2RS – AUT – 4RS select desired shooting mode [RAlt+V] – [RShift+V] – [RCtrl+V].



4. Set required gunsight reflector angle corresponding to chosen dive angle
5. Set fictitious target base
6. Set the GYRO-FIXED switch to the GYRO position [LShift+J]



7. Enter the minimum distance into gunsight [.]

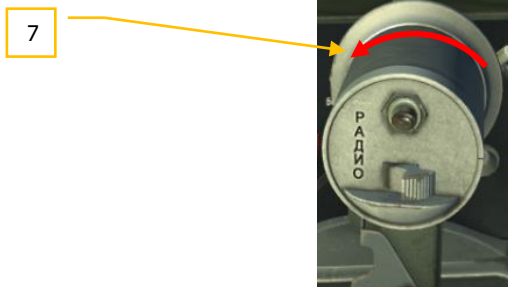

Actions in the target area:

1. Approach target at altitude of 1200 m. at required speed
2. Enable the ARMS CB [LShift + 5].



3. Ingress maneuver should be performed in such a way that target moved to the required target viewing angle (turn starting point)
4. At the moment when target reaches required viewing angle, start turning towards attack course with 60-120° roll and simultaneous dive entry. While entering the dive, set engine RPM of 90-92%
5. Turn and dive entry should be finished in such a way that aiming grid center was under the target



6. Flip the combat trigger down [LCtrl+Space], enter the maximum distance into gunsight [;]  
As a result, aiming reticle starts moving, reacting on aircraft maneuvers. Align aiming grid center with target's center.
7. While descending, keep central dot of aiming circle on the target
8. As soon as target fits the circle, formed by the diamonds, press the combat trigger (1 sec) [Space] and perform shooting



9. Immediately after shooting exit from the dive with G-factor of 3-3.5 units, simultaneously increasing engine RPM to TAKE OFF



# Combat Employment at Aerial Targets

Before the flight, make sure that the NETW, ARMS and SIGNAL CBs are enabled in rear cockpit.

Before air combat:

1. Enable ASP-FKP CB [LShift+7].
2. Enable HEAT SS CB [LShift + 8].
3. Enable GLOW SS CB [LShift + 9].
4. VOLUME SS - set the maximum volume
5. Using the PORT – STARB. BOTH select missile to be launched [RAlt+RCtrl+RShift+R].

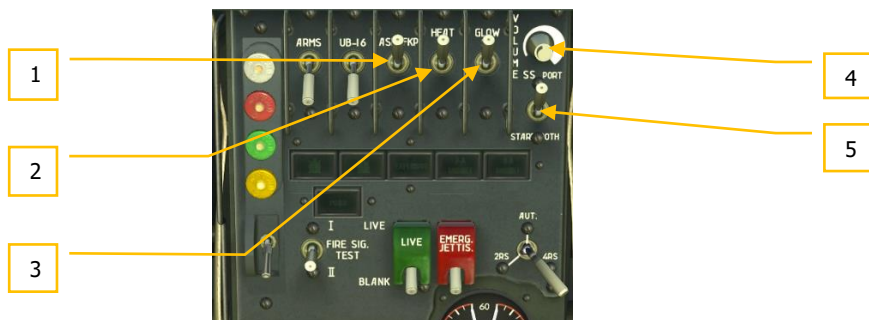

6. Set the gunsight reflector angle of 0°
7. Set the fictitious target base
8. GYRO-FIXED switch is in FIXED position [LShift+J]

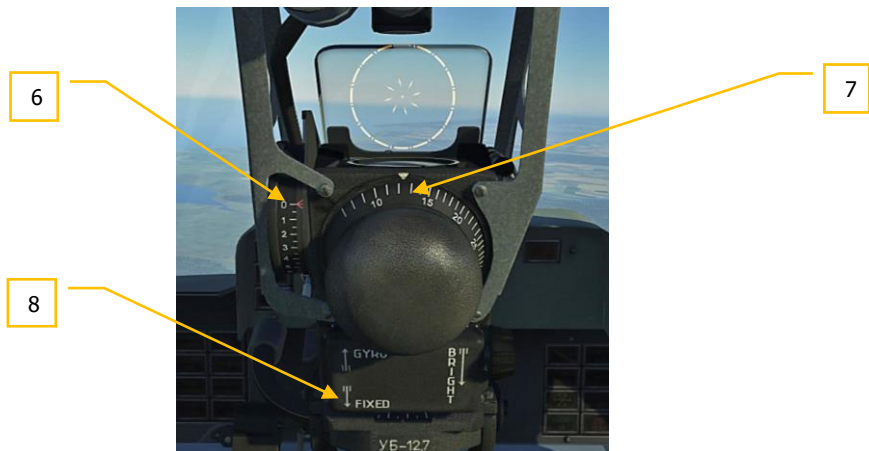

- Enter the maximum range [;]



**Note: Perform guided missile launch from rear hemisphere at target angles from 0/4 to 2/4, sun bearing should be not more than 200. Missile firing range is within 1200-2000 m, according to ASP-3NMU-39, closing speed is not more than 200 km/h. Attack exit perform at distance of not less than 1000 m. Launch is allowed when missile seeker lock signal is at maximum level (at allowed launch distance) and G-factor is less than 2 units.**

Air combat:

- Find a target and prepare for attack: distance - 2000 m, target should be seen at angle of 50 - 60°, altitude difference is 300 – 400 m.
- Enable ARMS CB [LShift + 5].



- Turn towards the target with roll angle of 50-60°, when the target reaches gunsight reflector remove roll, flip combat trigger [LCtrl+Space]
- Aim, by maneuvering aircraft achieve the maximum of the audial signal
- NO LAUNCH is off



**Note: NO LAUNCH signal indicates that allowed G-factor of more than 2 units is exceeded. Missile cannot be precisely pointed to the target**

6. When target visible size is 3-2 times smaller than the rangefinding circle, launch missile by pressing combat trigger [Space] for not less than 2-2.5 seconds.



7. Exit from attack run
8. Perform consecutive attack run

# L-39ZA



# L-39ZA

## Introduction

This section of the Flight Manual outlines the main differences between the L-39ZA and L-39C in terms of aircraft systems, equipment, engine and armament, with particular emphasis on work with the aircraft armament.

## General description of the aircraft

The L-39ZA is a two-seater training aircraft with the AI-25TL turbofan engine, designed for piloting and air navigation training in both easy and adverse weather conditions, day and night, as well as for destroying air targets in visual sight using R-60 and R-3S heat-seeking missiles, photo-firing on air targets, along with spot bombing with up to 500 kg aircraft bombs (with strike assessment) from diving, firing S-5 rockets (with strike assessment) from diving and firing the GS-23L gun as well the PK-3 machine-gun pod on ground targets.

The L-39ZA is equipped with four suspension points and has an increased max payload compared to the L-39C. Each inboard rack is designed for 500 kg payload, and each outboard one for 250 kg; however, the total payload does not exceed 1100 kg.

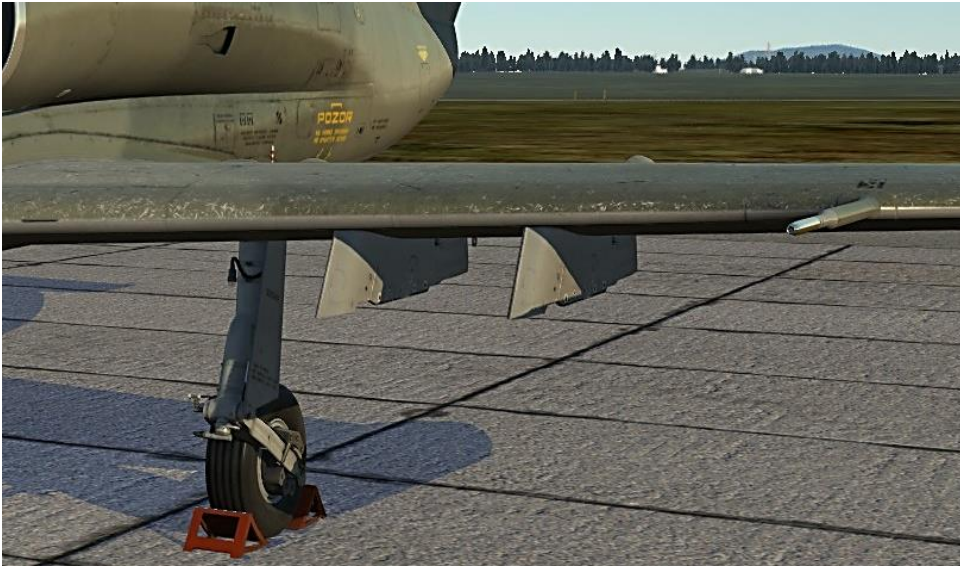

**Figure 163: L-39ZA hardpoints**

To extend flight ranges, 150-liter or 350-liter drop tanks (DT) can be attached to the inboard hardpoints.



**Figure 164: L-39ZA fuel tanks**

Due to the payload increase, the L-39ZA has a reinforced wing and landing gear structure.

L-39ZA is equipped with a 23mm GS-2-23L gun mounted in the fuselage nose section under the cockpit and covered with the fairing.

Necessary changes are made in the fuselage design as well as placing of some antennas and equipment; the skin of the front landing gear door is made of the alloy steel to protect against hot gunpowder gases.

To prevent the gun from firing while the angle of attack exceeds the preset value, the angle of attack sensor (DUA-3) is used. The sensor is located in the fuselage nose section on the LH side.



**Figure 165: L-39ZA AoA sensor and gun**

## Operating Limitations

1. Maximum takeoff weight, kg	5600
2. Maximum landing weight, kg	4800
3. Maximum permissible indicated airspeed without external stores or with two GMs (up to the 1300 m altitude), km/h	900
4. Maximum permissible Mach number without external stores or with two GMs (above 1300 m), km/h	0,8
5. Maximum permissible indicated airspeed with external stores, km/h/ KIAS	870
6. Maximum permissible Mach number with external stores	0,75
7. Maximum permissible g-loads:	
• For gross weight 4200 kg	+8/-4
• For gross weight 4500kg	+7/-3,5
• For gross weight 5000 kg	+5/-3
• For gross weight 5500 kg	+5/-2,5
8. Takeoff distance for concrete runway at the engine takeoff power with maximum takeoff weight, m	1,280
9. Lift-off speed with maximum takeoff weight, km/h	211
10. Landing ground run for concrete runway with the use of brakes at landing with maximum takeoff weight, m	1,070
11. Landing speed with maximum takeoff weight, km/h	190
12. Stalling speed (km/h) with external stores at weight 5600 kg	
• Flaps retracted	215
• Flaps at 25 deg	205
• Flaps at 44 deg	195
13. Stalling speed (km/h/ KIAS) with external stores at weight 4800 kg	
• Flaps retracted	202
• Flaps at 25 deg	200
• Flaps 44 deg	180



# Cockpit Equipment

## Front cockpit



**Figure 166: Front cockpit L-39ZA**

Some changes were made in the L-39ZA front cockpit, mainly related to adding an armament control panel to the left from the instrument panel and a combined control panel for guided missiles (GM) and the GS-23 gun on the LH side.

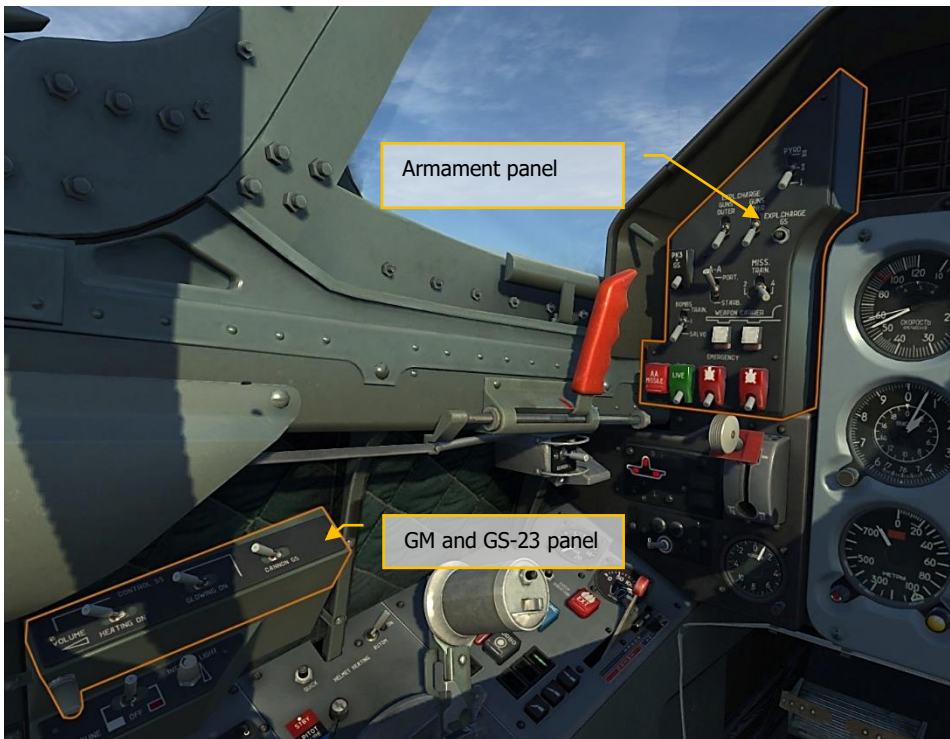

**Figure 167: Armament control panels**

A cockpit and instrument panel lighting control panel is located below the GM and GS-23 panel, as well as the RSNB TUNE button.



**Figure 168: Cockpit lighting control panel and the RSBN TUNE button**

CBs (circuit-breakers) and switches for armament control, as well as a new indicator for the attached aerial weapons and DTs were added to the front cockpit center panel.



**Figure 169: Center armament panel**

The start mode switch PRESERV – STARTING – COLD.ROTAT on the left engine control panel is located under the control panel and covered with a cap.



**Figure 170: The PRESERV -STARTING -COLD. ROTAT switch**

Switch OFF JPT REG is not provided.

The AOA-HTR CB for heating the DUA-3 sensor and the ARMS CB for powering the main armament system are also installed on the main switch panel.

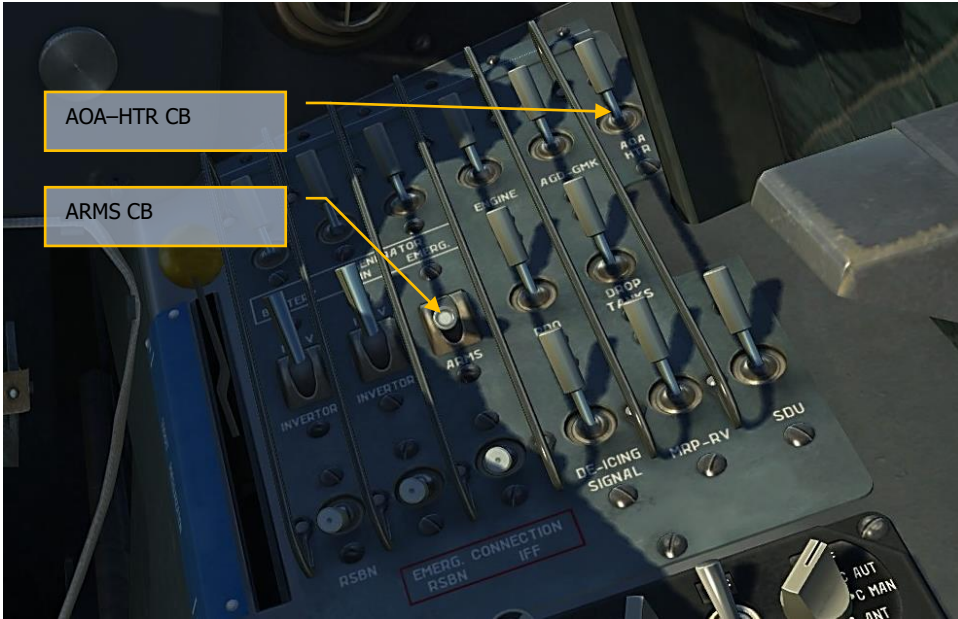

Figure 171: Main switch panel

## Rear Cockpit



**Figure 172: Rear cockpit L-39ZA**

The indicator for attached aerial weapons and DTs is installed in the rear cockpit instead of the SUSPENDED LOADS and SS signals.

The DROP TANKS signal indicating that the DTs are empty is added to the RH annunciator panel.

# Aircraft and Engine Systems

## Fuel system

The L-39ZA fuel system includes the main system as well as the system of wing tip tanks and drop tanks.

The main fuel system incorporates five fuselage tanks. To extend the flight range, another two fuel tanks may be attached rigidly on the wing tips; additionally, 150-liter or 350 liter drop tanks (DT) can be used. DTs can be attached to the inboard pylons only.

No.	Fuel tanks	Capacity, l/kg	Total capacity, l/kg
1	Fuselage	1100/824	1100/824
2	Two wing tip tanks	200/156	1300/980
3	Two drop tanks (2x150 l)	300/234	1600/1214
4	Two drop tanks (2x350 l)	700/580	2000/1560

Fuel is used in the following order:

- Fuselage tanks fuel is used until 575-625 kg is left.
- Drop tanks (if attached).
- Wing tip tanks.
- The rest of the fuel from the fuselage tanks is used.

Drop tanks status is indicated on the external stores indicator in both cockpits.



**Figure 173: External stores indicator**



When the DTs are emptied, the DROP TANKS signal lights up on the RH annunciator panel in both cockpits.



Figure 174: The DROP TANKS annunciator panel

When the wing tip tanks are emptied, the WING TIP TANKS signal lights up on the RH annunciator panel in both cockpits.



Figure 175: The WING TIP TANKS annunciator panel

To switch on the DT and wing tip tank status indication system, close the DROP TANKS CB on the main switch panel in the front cockpit.

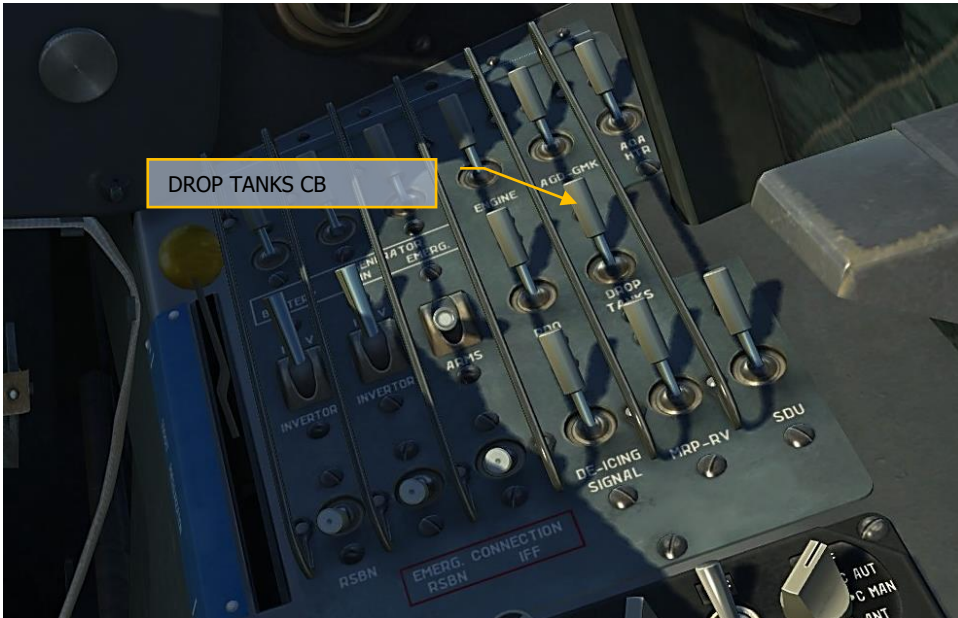
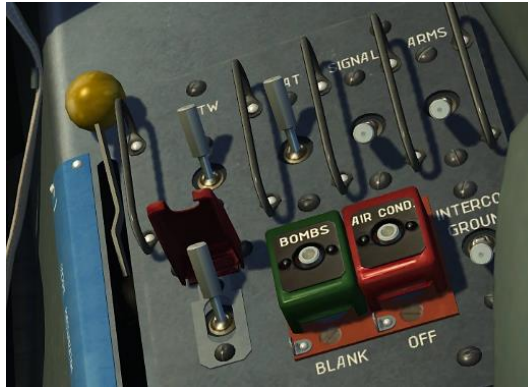

**Figure 176: The DROP TANKS CB**

The DTs can be jettisoned in flight. To perform this, set the RH EMERGENCY switch on the armament panel in the front cockpit to the upper position. DTs can be also jettisoned by setting the rear cockpit EMERG. JETTIS switch to the forward position.



**Figure 177: The EMERGENCY switch in the front cockpit**



**Figure 178: The EMERG. JETTIS. switch in the rear cockpit**

After the DT jettison, the corresponding indication on the external stores indicator goes off.

## PT-12 engine overheat control system

The PT-12 system for the L-39ZA has an additional function designed for decreasing fuel supply from the main fuel system while firing the gun.

This precaution is made to prevent the gunpowder gases from getting into the inlet.

The PT-12 system starts operation when the gun firing mode is selected and the trigger button is pressed.

Fuel supply decrease occurs the whole time when the trigger button is pressed; the engine speed can be decreased down to idle.

After the trigger button is released, the speed returns to its previous value.

There is no switch OFF JPT REG in the L-39ZA. The PT-12 CB performs this function.

## Aircraft equipment

The L-39ZA is equipped with the DUA-3 angle of attack sensor.

The DUA-3 sensor is included in the GS-23 armament system and signals the pilot that the critical angle of attack is reached, while also blocking the gun firing control if the angle of attack exceeds 6 degrees.

The DUA-3 is a vane-type sensor mounted on the aircraft.

A potentiometer is secured in the sensor casing, and the wiper is connected with the vane, which follows the airflow direction.

The voltage proportional to the aircraft angle of attack is picked up from the potentiometer.

There are heaters provided to allow operation at low temperatures and icing.

To heat the DUA-3, close the AOA-HTR CB on the main switch panel in the front cockpit.

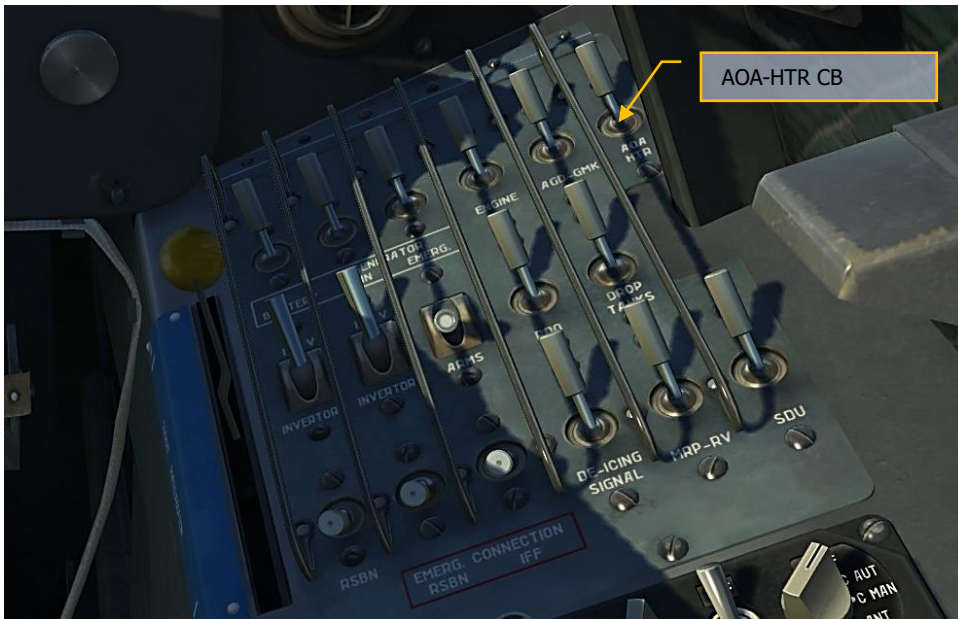

**Figure 179: The AOA-HTR CB on the main switch panel**

A velocity sensor is incorporated in the PST (pitot-static tube) dynamic circuit to prevent the gun from firing at speeds below 400 km/h.

# Armament and Combat Employment

## Aircraft Armament

The L-39ZA is equipped with bombing, missile, gun and machine-gun armament. It has the ASP 3NMU-39 3 gunsight, FKP-2-2 gun camera and EKSR-46 auxiliary armament.

Armament, gunsight and photo control equipment of the L-39ZA are used for the following tasks:

- Spot bombing from diving with 50- to 500-kg aircraft bombs.
- Aimed fire with rockets of S-5 type on ground targets from diving.
- Launch of guided missiles P-60 (P-3S) on air targets.
- Aimed fire from GS-23 gun on ground targets from diving.
- Aimed fire from PK-3 machine-gun pod on ground targets from diving.

To attach weapons, the L-39ZA is equipped with two outboard pylons L39-M-619, L39-M-620 and two inboard pylons L39-M-639, L39-M-640.

The ASP-ZNMU-39 3 sight installed on the L-39ZA is designed for a 23mm cartridge ballistics of the GS-23L gun. On the contrary, the sight on the L-39C is designed for the 12.7 mm machine-gun cartridge ballistics.

In other respects the ASP-3NMU-39 3 sight is similar to the ASP-3NMU-39.

**Armament controls are arranged in the armament panel, center panel and in the LH side of the front cockpit. The trigger button is located on the aircraft control stick in the front cockpit only**

## Bombing Armament

The bombing armament incorporates the following:

- Pylons
- Aircraft bombs
- Main aircraft bomb release control system
- Emergency aircraft bomb release system

Bombs are attached to the pylons.

Twin racks L39-M559 (hereinafter TR) can be installed on the pylons to use aircraft bombs with calibre up to 100 kg.

Main control system is designed for live bomb release only, solitarily or in a salvo from the outboard pylons and only in a salvo from the inboard pylons at the aircraft flight speed above 310 km/h (at speeds below 310 km/h the system is blocked).

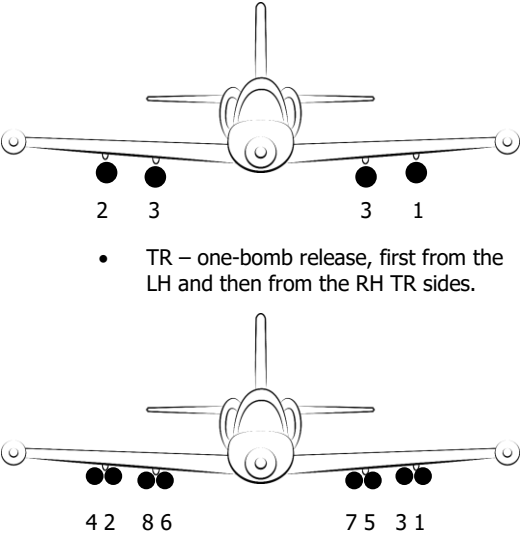
No.	Switch (Signal)	Function
<b>Bombing armament control and signaling elements in the front cockpit</b>		
<b>Main switch panel</b>		
1	CB ARMS	Weapon circuits power supply
<b>Armament panel</b>		
2	BOMBS TRAIN. – 1 – SALVO Switch	Bombing mode selection <b>Mode 1:</b> <ul style="list-style-type: none"> <li>• outboard pylons – one-bomb release, first from the LH pylon and then from the RH one.</li> <li>• inboard pylons – in a salvo.</li> </ul>  <ul style="list-style-type: none"> <li>• TR – one-bomb release, first from the LH and then from the RH TR sides.</li> </ul>

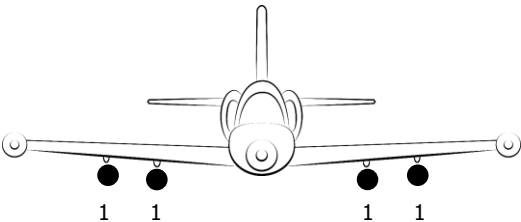
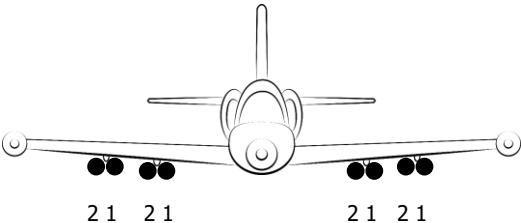
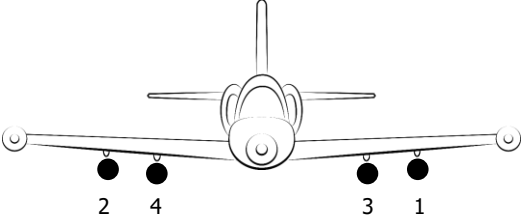
No.	Switch (Signal)	Function
		<p><b>SALVO Mode:</b></p> <ul style="list-style-type: none"> <li>outboard and inboard pylons – in a salvo.</li> </ul>  <ul style="list-style-type: none"> <li>TR – at first from LH side of all TRs, then from RH side of all TRs (press the trigger button twice).</li> </ul>  <p><b>TRAIN Mode (interval 0.15 s):</b></p> <ul style="list-style-type: none"> <li>outboard and inboard pylons – one-bomb release, first from the LH pylon and then from the RH one.</li> </ul> 

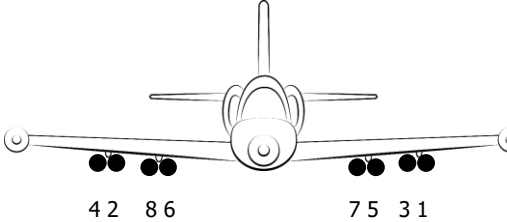
No.	Switch (Signal)	Function
		<p>If the TRs are attached, the release sequence is as follows:</p> <ul style="list-style-type: none"> <li>• the left bomb from the TR of LH pylon</li> <li>• the left bomb from the TR of RH pylon</li> <li>• the right bomb from the TR of LH pylon</li> <li>• the right bomb from the TR of RH pylon</li> </ul> 
3	WEAPON CARRIER buttons	Pylons selection and deselection. Press the white LH button to select the outboard pylons; press the white RH button to select the inboard pylons. Press the brown buttons to deselect the pylons.
4	EMERGENCY switches	Emergency bomb release. The LH switch is designed for emergency release from the outboard pylons; the RH switch is designed for emergency release from the inboard pylons. TR are also released in case of emergency release.
5	LIVE switch	Used to select blank or live bomb release from the emergency aircraft bomb release system.
<b>Center panel</b>		
6	LAUNCH switch	Trigger button power supply.
7	CB BOMBS	Main aircraft bomb release control system power supply.
8	External stores indicator	Indicates attachment of aircraft bombs to the pylons and TR with bombs.
9	PUS-0 signal	Indicates readiness of PUS-36 DM to bombs release.
<b>Signals</b>		
10	STAND ALERT	Indicates readiness of the armament control system. The signal lights up at speed greater than 310 km/h.
11	EXPLOSIVE	Indicates setting the LIVE switch in the upper position LIVE.
<b>Bombing armament control and indication elements in the rear cockpit</b>		
12	CB ARMS	Powers the CB ARMS in the front cockpit. This CB overrides the CB ARMS in the front cockpit.
13	EMERG.JETTIS. switch	Emergency bomb release. When this switch is ON, bombs from all pylons are released simultaneously.
14	BOMBSLIVE – BLANK switch	Live/blank bomb release via the emergency aircraft bomb release system. The switch shall be in the neutral position.



No.	Switch (Signal)	Function
		<b>Important: This switch overrides the LIVE switch in the front cockpit. When the switch in the rear cockpit is set to LIVE or BLANK, bombs are released live or blank respectively regardless of the LIVE switch position in the front cockpit.</b>
15	External stores indicator	Indicates attachment of aircraft bombs to the pylons and TR with bombs.
16	ARMAMENT FIRE signal	Indicates pressing of the trigger button in the front cockpit.
17	STAND ALERT signal	Indicates readiness of the armament control system. The signal lights up at speed greater than 310 km/h.
18	EXPLOSIVE signal	Indicates setting the switch LIVE in the upper position LIVE in the front or rear cockpit.

## Rocket Armament

The rocket armament includes the following:

- Four rocket pads type UB-16-57UMP
- 64 rockets type S-5, calibre 57 mm
- Two fire control devices type PUS-36 DM
- Pylons
- Electrical fire control system

The UB-16-57UMP pads are attached to the pylons.

The UB-16-57UMP is designed for distributing and pulsing the electric fuses of rockets of the four pads. The electrical rocket fire control system permits firing at a flight speed above 310 km/h (at speeds lesser than 310 km/h, the firing control system is blocked).

No.	Switch (Signal)	Function
<b>Rocket armament control and indication elements in the front cockpit</b>		
<b>Main switch panel</b>		
1	CB ARMS	Weapon circuits power supply
<b>Armament panel</b>		
2	WEAPON CARRIER buttons	Pylons selection and deselection. Press the white LH button to select the outboard pylons; press the white RH button to select the inboard pylons. Press the brown buttons to deselect the pylons.
3	MISS. TRAIN. – 2 – 4 switch	Launch option selection.  2 – after each pressing of the trigger button, two missiles from LH and RH pads are launched

No.	Switch (Signal)	Function
		<p>4 – after each pressing of the trigger button, four missiles from LH and RH pads are launched</p> <p><b>TRAIN.</b> – all 32/64 missiles are launched by pressing of the trigger button once;</p> <p>NOTE: When all four UB-16-57UMPs are selected, 32 rockets are launched first from the outboard pylons and then 32 rockets are launched from the inboard pylons.</p>
4	EMERGENCY switches	Emergency release of the UB-16-57UMP pads. The LH switch is designed for emergency release from the outboard pylons; the RH one is designed for emergency release from the inboard pylons.
<b>Center panel</b>		
5	CB LAUNCH	Trigger button power supply.
6	CB MISSILE	Power supply of the PUS-36DM and UB-16 pads, two signals PUS-0 light up after closing the CB MISSILE.
7	External stores indicator	Indicates attachment of UB-16-57UMP to the pylons.
8	PUS-0 signals	Indicates readiness of PUS-36 DM for firing.
<b>Signals</b>		
9	STAND ALERT	Indicates readiness of the armament control system. The signal lights up at speed greater than 310 km/h..
<b>Rocket armament control and indication elements in the rear cockpit</b>		
10	CB ARMS	Power supply of the CB ARMS in the front cockpit. This CB overrides the CB ARMS in the front cockpit.
11	EMERG. JETTIS. switch	Emergency release of the UB-16-57UMP pads. When turning on this switch, all UB-16-57UMPs from all pylons are released simultaneously.
12	External stores indicator	Indicates attachment of UB-16-57UMP to the pylons.
13	ARMAMENT FIRE signal	Indicates pressing of the trigger button in the front cockpit.
14	STANDALERT signal	Indicates readiness of the armament control system. The signal lights up at speed greater than 310 km/h.

## Missile armament

The missile armament includes the following

- Two R-60 (R-3S) missiles.
- Two APU P-60 ZA (APU-13M 1) missile launchers.
- Pylons.
- MP-28A g-sensor.
- Power supply, indication and missile launch control system.
- Emergency missile launch system.

The missile armament allows launching missiles at aircraft flight speed above 310 km/h.

MLs are designed for attachment and power supply of R-60 (R-3S) missiles.

Missile launchers are installed on the outboard pylons only.

The MP-28A g-sensor is designed for measuring g-loads and indication when the g-load exceeds 2.

No.	Switch (Signal)	Function
<b>Missile armament control and indication elements in the front cockpit</b>		
<b>Main switch panel</b>		
1	CB ARMS	Weapon circuits power supply.
<b>Armament panel</b>		
2	WEAPON CARRIER buttons	Pylons selection and deselection. Press the white LH button to select the outboard pylons; press the white RH button to select the inboard pylons. Press the brown buttons to deselect the pylons.
3	A-APORT. – STARB. Switch	Launch options selection. Missiles are launched in turn only, depending on switch position; simultaneous missile launch is impossible. PORT. – LH missile is selected for launch STARB. – RH missile is selected for launch
4	EMERGENCY switches	Emergency release of missiles from ML.
	AA MISSILE button	Emergency missile launch. Targeting at emergency launch is impossible.
<b>Center panel</b>		
5	CB LAUNCH	Power supply of the trigger button.
6	CB MISSILE	Power supply of the ML and missiles.
7	External stores indicator	Indicates attachment of ML with missiles to the pylons.
<b>Missile and GS-23 panel</b>		
8	CB HEATING	Power supply of heating circuits of missile seeking head and ROCKETS HEATING signal in the rear cockpit.
9	CB GLOWING	Power supply of the g-sensor, missile glow circuits and GLOWING ON signal in the rear cockpit.
10	VOLUME SS handle	Volume control for the sound of target lock-on by heat-seeking head
<b>Signals</b>		
11	STAND ALERT	Indicates readiness of the armament control system. The signal lights up at speed greater than 310 km/h
12	NO LAUNCH	Indicates that the maximum allowable g-load value (2) is exceeded. Accurate missile targeting is impossible at such g-load.
<b>Missile armament control and indication elements in the rear cockpit</b>		
13	CB ARMS	Power supply of CB ARMS in the rear cockpit. This CB overrides the CB ARMS in the front cockpit.
14	EMERG. JETTIS. switch	Emergency release of ML with missiles. When turning on this switch, MLs with missiles from all pylons are released simultaneously.

No.	Switch (Signal)	Function
15	External stores indicator	Indicates attachment of ML with missiles to the pylons.
16	STAND ALERT signal	Indicates readiness of the armament control system. The signal lights up at speed greater than 310 km/h
17	NOLAUNCH signal	Indicates that the maximum allowable g-load value (2) is exceeded.
18	ARMAMENT FIRE signal	Indicates pressing the trigger button in the front cockpit.
19	GLOWING ON signal	Indicates the power supply status of the g-sensor and missile glow circuits. Lights up after closing the CB GLOWING.
20	ROCKETS HEATING signal	Indicates the power supply of the missile seeker head's heating circuits. Lights up after closing the CB HEATING.

## GS-23L Gun

GS-23L is a 23-mm twin-barrel aircraft gun designed for combating air targets and lightly armoured ground (sea) targets.

Gun armament includes the following:

- Gun pod
- Twin-barrel GS-23L gun
- Cartridge feeding and case extraction system
- Electric fire control system

The gun's max firing rate is 3,400 shots per minute, the payload is 150 cartridges. The effective firing range is 2 km.

The following 23mm cartridges are used:

- BZT-23GS (armour piercing-incendiary-tracing)
- OFZ-23-AM-GS (high explosive-incendiary)
- OFZT-23-AM-GS (high explosive-incendiary-tracing)
- FZ-23-GS (high explosive-incendiary)

Firing the gun is possible in the following conditions:

- The front landing gear is retracted
- Speed is no less than 400 km/h
- The angle of attack does not exceed 6 degrees
- The positive G no more than 6; the negative G no more than -2.

The GS-23L is equipped with a pyrotechnical reload system. A cassette equipped with three pyrocartridges is installed for reloading. Pyrocartridge actuation triggers the gun automatic system

and reloading. A set of three pyrocartridges allows loading the gun with two reloads in case of a jammed cartridge.



Figure 180: GS-23L Gun

No.	Switch (Signal)	Function
<b>Gun armament control and indication elements in the front cockpit</b>		
<b>Main switch panel</b>		
<b>1</b>	CB ARMS	Weapon circuits power supply.
<b>Armament panel</b>		
<b>2</b>	EXPL.CHARGE.GS button	Loading the gun.
<b>3</b>	PYROIII-II-I switch	Selecting pyrocartridges for loading the gun, as well for reloading in case of jammed cartridges. Position I is used to load the gun; in case of jamming, set the switch in position II and press the EXPL.CHARGE.GS button. In case of repeated jamming, set the switch in position III and press the EXPL.CHARGE.GS button.
<b>4</b>	PK3+GS switch	Firing the gun and machine-gun pods simultaneously.  Set the switch in the upper position and press the trigger button.  When this switch is on, use of BA, rockets and missiles is blocked.
<b>Center panel</b>		
<b>5</b>	CB LAUNCH	Power supply of the trigger button.
<b>6</b>	DEBLOCK.GUNS WING+GS button	Releases the blocking that prevents PK-3 and GS-23 from firing on the ground. Used to adjust the gun and machine-gun pods on the ground.

No.	Switch (Signal)	Function
<b>Missile and GS-23 panel</b>		
7	CB CANNON GS	Switches the gun on.
<b>Signals</b>		
8	STAND ALERT	Indicates readiness of the armament control system. The signal lights up at speed greater than 400 km/h
9	"α" (Alpha)	Indicates that the allowable angle of attack was exceeded and/or the speed decreased below 400 km/h when firing.
<b>Gun armament control and indication elements in the rear cockpit</b>		
10	CB ARMS	Power supply of the CB ARMS in the rear cockpit. This CB overrides the CB ARMS in the front cockpit.
11	STANDALERT signal	Indicates readiness of the armament control system. The signal lights up at speed greater than 400 km/h
12	ARMAMENT FIRE signal	Indicates pressing the trigger button in the front cockpit.

## PK-3 Machine-Gun Pod

Machine-gun armament includes the following:

- Four PK-3 machine-gun pods
- Twelve 7.62mm machineguns
- Electric fire control system
- Emergency fire control system

The PK-3 can be installed on both inboard and outboard pylons. Each PK-3 contains three 7.62mm machineguns. There are no flight speed limitations on PK-3 firing. It is possible to fire inboard and/or outboard PK-3s simultaneously.



Figure 181: The PK-3 machine-gun pod

No.	Switch (Signal)	Function
<b>Machine-gun armament control and indication elements in the front cockpit</b>		
<b>Main switch panel</b>		
1	CB ARMS	Weapon circuits power supply
<b>Armament panel</b>		
2	WEAPON CARRIER buttons	Pylons selection and deselection. Press the white LH button to select the outboard pylons; press the white RH button to select the inboard pylons. Press the brown buttons to deselect the pylons.
3	EXPL.CHARGE GUNS OUTBC GUNS INNER switches	Loading the outboard and inboard machine-gun pods.
4	PK3+GS switch	Firing the gun and machine-gun pods simultaneously.  Set the switch in the upper position and press the trigger button.  When this switch is on, use of BA, rockets and missiles is blocked.
	EMERGENCY switches	Emergency release of PK-3.
<b>Center panel</b>		
5	A3C LAUNCH	Power supply of the trigger button.
6	External stores indicator	Indicates attachment of the PK-3 on pylons.
7	CB GUN WING OUTBCGUN WING INNER	Power supply of the fire control system on the outboard and inboard PK-3s.

No.	Switch (Signal)	Function
8	DEBLOCK.GUNS WING+GS button	Releases the blocking that prevents PK-3 and GS-23 from firing on the ground. Used to adjust the gun and machine-gun pods on the ground.
9	EMERG.FOTO GUNS WING INNER switch	Releases the fire blocking of the inboard PK-3 and PFK-3 in case of main generator fault. PFK-3 (strike assessment camera) is not implemented in the simulator.
<b>Signals</b>		
10	STAND ALERT	Indicates readiness of the armament control system.
<b>Machine-gun armament control and indication elements in the rear cockpit</b>		
11	CB ARMS	Power supply of CB ARMS in the rear cockpit. This CB overrides the CB ARMS in the front cockpit.
12	External stores indicator	Indicates attachment of the PK-3 to pylons.
13	ARMAMENT FIRE signal	Indicates pressing of the trigger button in the front cockpit.



# Control and Indication Elements in the Front Cockpit

## Armament panel

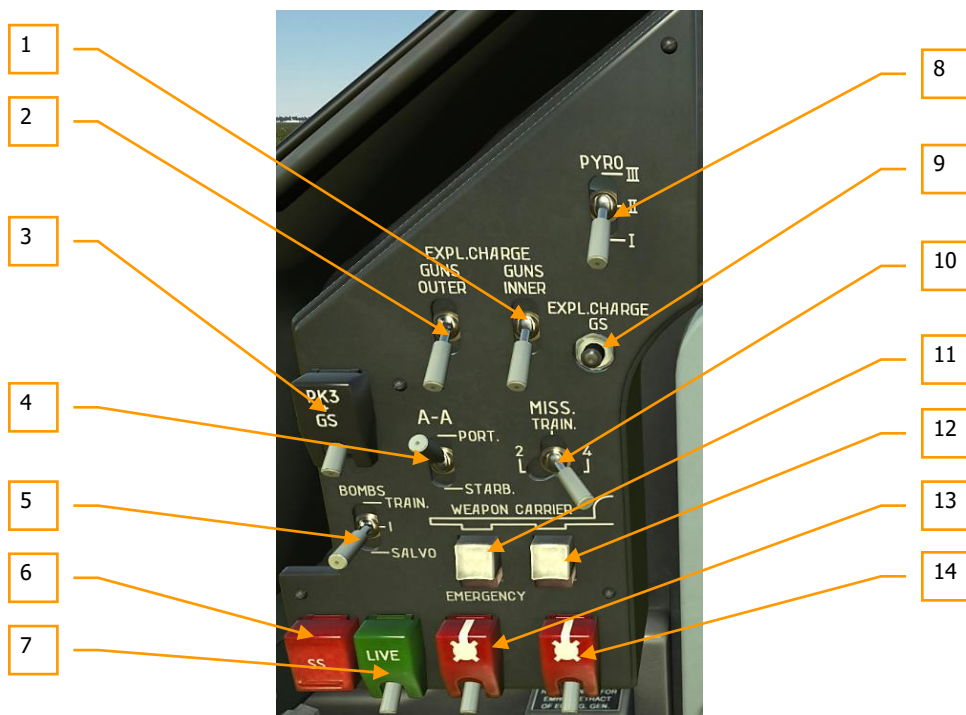
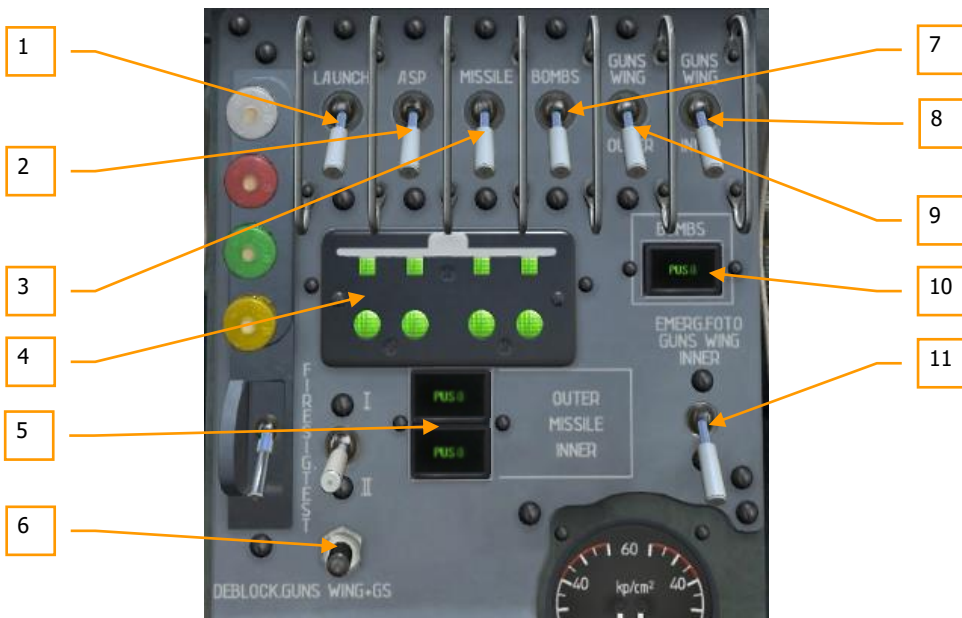

**Figure 182: Armament panel**

1. EXPL.CHARGE GUNS INNER switch
2. EXPL.CHARGE GUNS OUTBC switch
3. PK3+GS switch
4. Two-position A-A PORT. – STARB switch
5. Three-position BOMBS TRAIN. – 1 – SALVO switch
6. AA MISSILE button.
7. LIVE switch.

8. PYRO III-II-I switch.
9. EXPL.CHARGE GS switch.
10. Three-position MISS. TRAIN. – 2 – 4 switch
11. WEAPON CARRIER button for outboard pylons.
12. WEAPON CARRIER button for inboard pylons.
13. EMERGENCY switch for outboard pylons
14. EMERGENCY switch for inboard pylons

## Center Panel

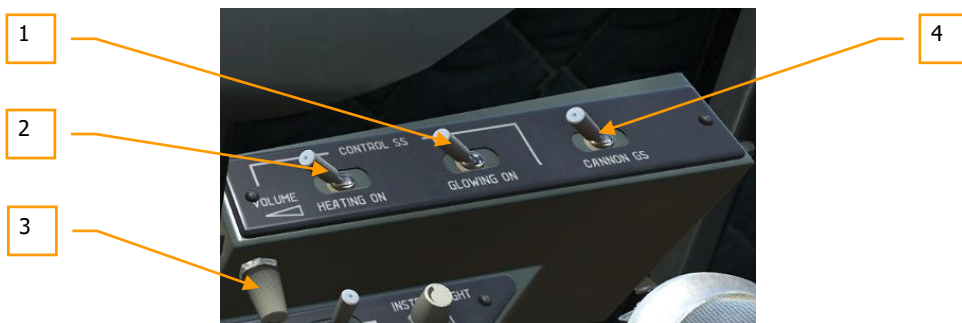

**Figure 183: Center Panel**

1. LAUNCH CB
2. ASP CB for actuating ASP-3NMU-39 sight and FKP-2-2 gun camera
3. MISSILE CB
4. External stores indicator
  - The upper row indicates attachment of single bombs, rocket launchers, missile launchers, bomb racks and PK-3 gunpads before arming (before EXPL.CHARGE GUNS OUTER GUNS INNER).

- The lower row indicates attachment of bombs on rack, missile on launchers and PK-3 gunpad after arming (after EXPL.CHARGE GUNS OUTER GUNS INNER).
5. PUS-0 signals for outboard and inboard UB-10 pads
  6. DEBLOCK.GUNS WING+GS button
  7. BOMBS CB
  8. GUN WING OUTBC switch
  9. GUN WING INNER switch
  10. PUS-0 switch for BA
  11. EMERG.FOTO GUNS WING INNER switch

## R-3S, R-60 and GS-23 Control Panel



**Figure 184: R-3S, R-60 and GS-23 Control Panel**

1. GLOWING ON CB
2. HEATING ON CB
3. VOLUME SS handle
4. CANNONGS CB

## Annunciator Panels



**Figure 185: Annunciator Panels**

1. EXPLOSIVE signal. In L-39C it was located on the center panel
2. "α" (AoA) signal

## Bombs Delivery

Before the flight, make sure that the NETW, ARMS and SIGNAL CBs are enabled in rear cockpit.

Bombing parameters for L-39ZA are similar to those for L-39C.

### Before the Target Approach

1. Enable the ARMS CB [RCtrl+3]

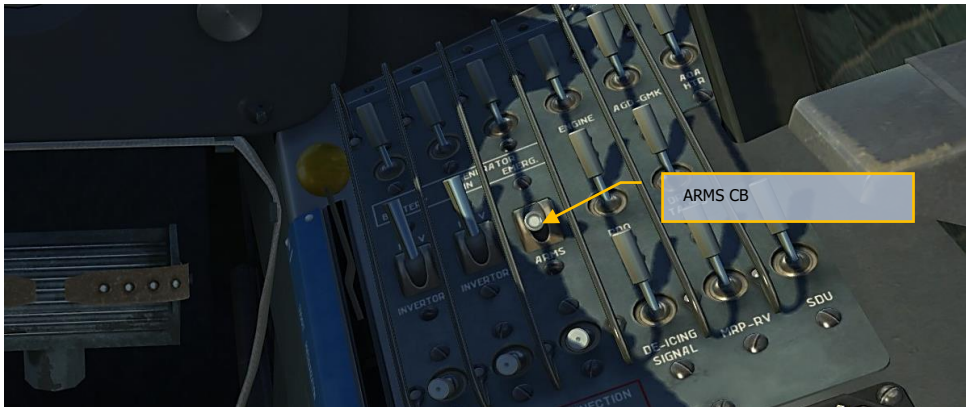

2. Enable the ASP CB [LAlt+2]

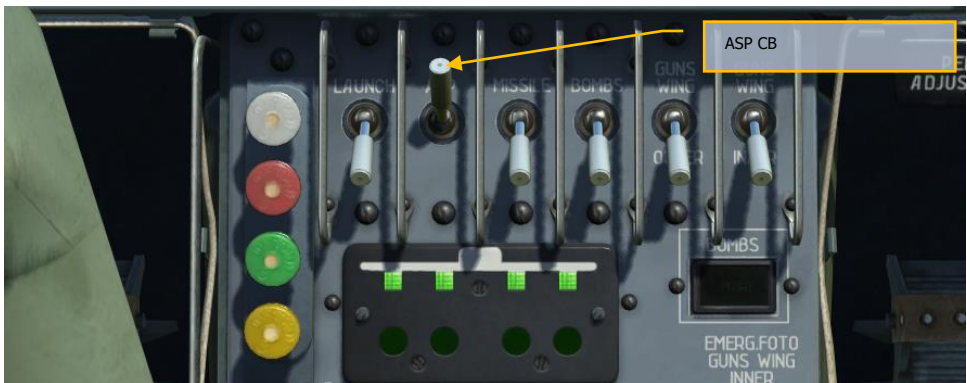

## DCS [L-39 ALBATROS]

3. Set the reflector inclination angle and lift the seat to the upper position in order to see the center sight point and the upper part of the distance measuring circle. Set the fictitious target base.
4. Set the GYRO – FIXED switch to FIXED [LShift+J]
5. Enter the minimum range into the sight [.]
6. Enable BOMBS CB [LAlt+4]



7. Select the pylons using the WEAPON CARRIER buttons.  
[LShift+6] – inner  
[LShift+5] – outer
8. Select the BA use mode with the BOMBS TRAIN. – 1 – SALVO switch.  
[LAlt+LCtrl+LShift+S] – up.  
[LAlt+LCtrl+LShift+X] – down.

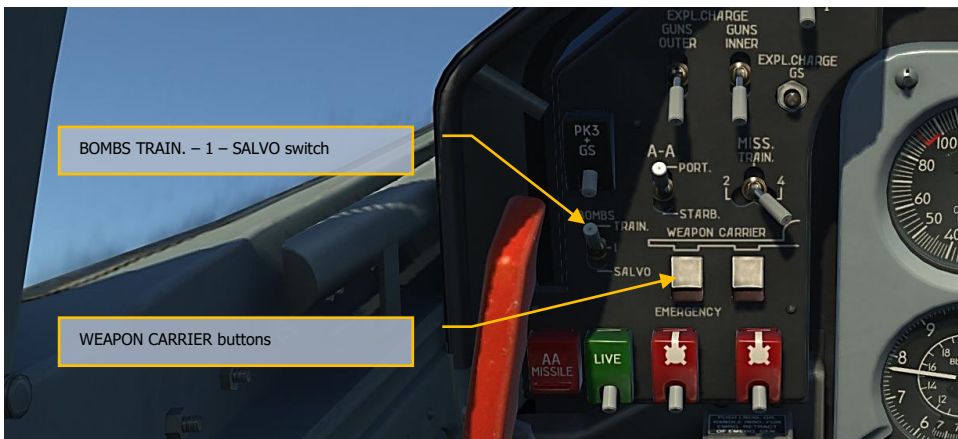

## Actions in the Target Area

1. Enable LAUNCH CB [LAlt+1]

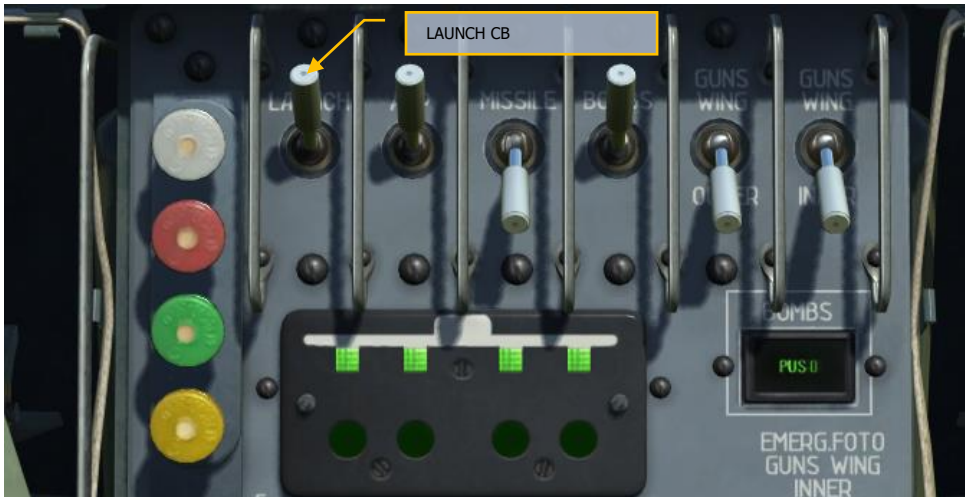

2. Arrange a target approach maneuver so that the target moves to the specified sight angle
3. Start a turn to the bombing run with a roll of 60- 120° and simultaneous diving at the moment of target approach to the specified sight angle. Set the specified speed after the diving is established
4. Finish the turn and the diving so that the sight reticle center is under the target at the distance equal to one radius of the sight reticle circle having a constant diameter
5. Lift the TB [LCtrl+Space] cap; as aircraft descends, the sight reticle center point will shift to the target, and the speed and altitude will approach the nominal release parameters
6. Press the TB [Space] and release a bomb when the specified speed and altitude are reached, and sight center point is aligned with the target
7. Pull out from dive with g-load equal to 4 to 5 with simultaneous acceleration up to the takeoff power

## Rockets Firing

Before the flight, make sure that the NETW, ARMS and SIGNAL CBs are enabled in rear cockpit.

The L-39ZA firing parameters are similar to the L-39C's.

### Before the Target Approach

1. Enable ARMS CB [RCtrl+3]



2. Enable ASP CB [LAlt+2]

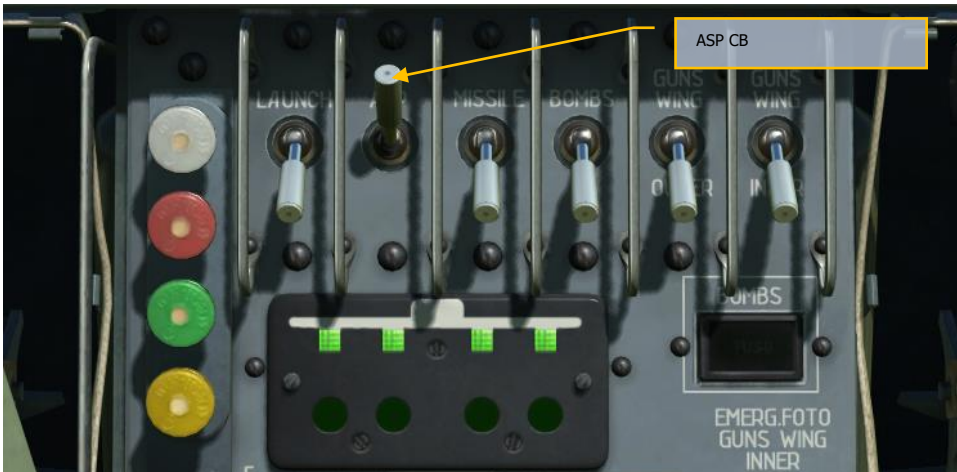



3. Set the sight reflector inclination angle
4. Set the fictitious target base
5. Set the GYRO – FIXED switch to FIXED [LShift+J]
6. Enter the minimum range into the sight [.]
7. Enable MISSILE CB [LAlt+3].

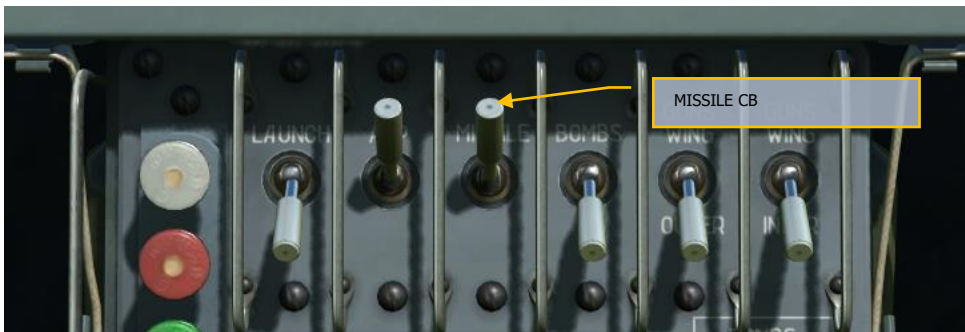

8. Set the firing option via the MISS. TRAIN. – 2 – 4 switch [RShift+V] — [RAlt+V] — [RCtrl+V]
9. Select the pylons using the WEAPON CARRIER buttons [LShift+6] — inner [LShift+5] — outer

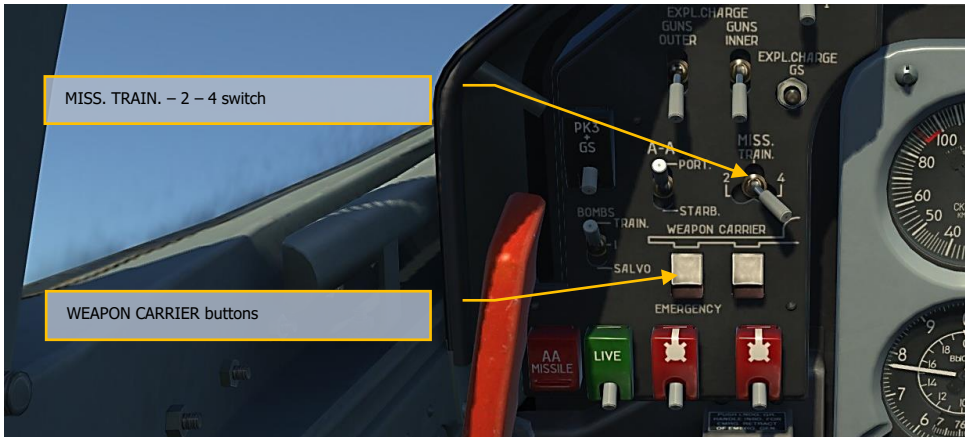

## Actions in the Target Area

1. Enable LAUNCH CB [LAlt+1]



2. Set the GYRO – FIXED switch to GYRO [LShift+J].
3. Arrange a target approach maneuver so that the target moves to the specified sight angle (turn starting point)
4. Start a turn to the attack heading with a roll of 60- 120° and simultaneous diving at the moment of target approach to the specified sight angle. During the diving, set the engine speed to idle for the dive angle 30° and to 90-92% for the dive angle 20°
5. Finish the turn and diving so that the sight reticle center is under the target
6. Lift the TB [LCtrl+Space], cap, enter the maximum range [;] into the sight, align the sight reticle center with the target center
7. Hold the sight reticle center on the target during the dive
8. When the target fits into the circle formed by the sight reticle rhombi, press the TB [Space] and perform the launch
9. Immediately after the launch, pull out with the g-load 3 to 3.5 and simultaneously accelerate to the takeoff power
10. After pulling out, enter the minimum range into the sight and commence the next attack maneuver

## Air-to-Air Missiles

Before the flight, make sure that the NETW, ARMS and SIGNAL CBs are enabled in rear cockpit.

### Before Air Combat

1. Enable ARMS CB [RCtrl+3]

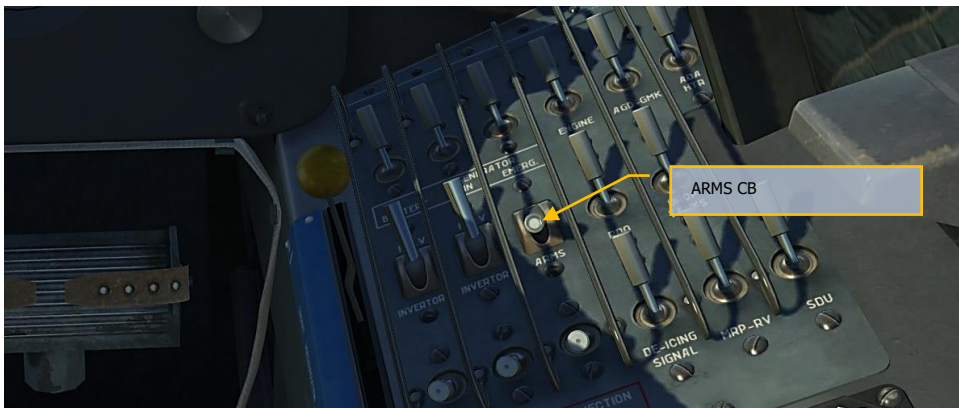

2. Enable ASP CB [LAlt+2]

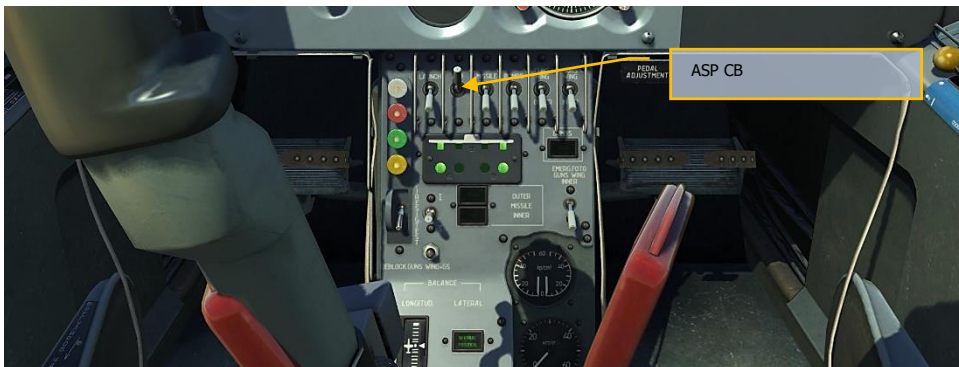

3. Set the sight reflector inclination angle to 0°
4. Set the fictitious target base
5. Set the GYRO – FIXED switch to FIXED [LShift+J]
6. Enter the maximum range into the sight [;]
7. Enable MISSILE CB [LAlt+3]



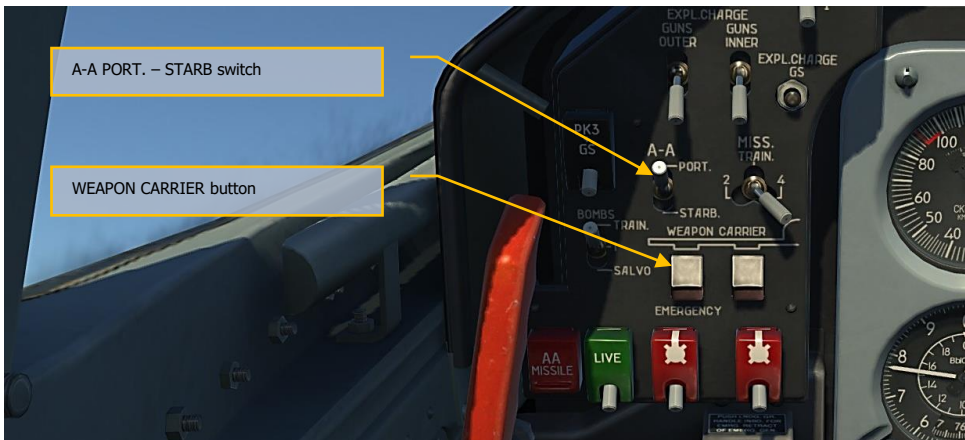

## Air Combat

1. Locate the target and take the initial attack position, range 2000 m, angle of sight to the target 50 - 60°, excessive or deficient altitude 300 to 400 m. Lift the TB cap
2. Enable LAUNCH CB [LAlt+1]



3. Perform the corrective turn to the target with a roll of 50 - 60°; remove the roll at target approach to the sight reflector
4. Perform the sighting, identify the maximum acoustic signal by turning the aircraft.
5. The NO LAUNCH signal shall be off
6. Launch the missile by pressing the TB at the moment when the visible target dimensions are 3-2 times less than the distance measuring circle diameter
7. Recover from the attack
8. Commence the next attack run



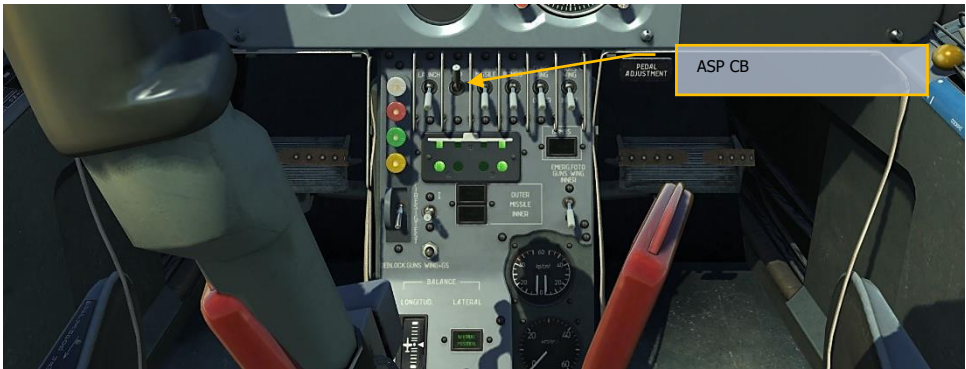

4. Set the sight reflector inclination angle
5. Set the fictitious target base
6. Set the GYRO – FIXED switch to FIXED
7. Enter the minimum range into the sight [.]
8. Enable CANNON GS CB [LShift+0]
9. Press the EXPL.CHARGE GS button to load the gun [LAlt+LCtrl+LShift+S]

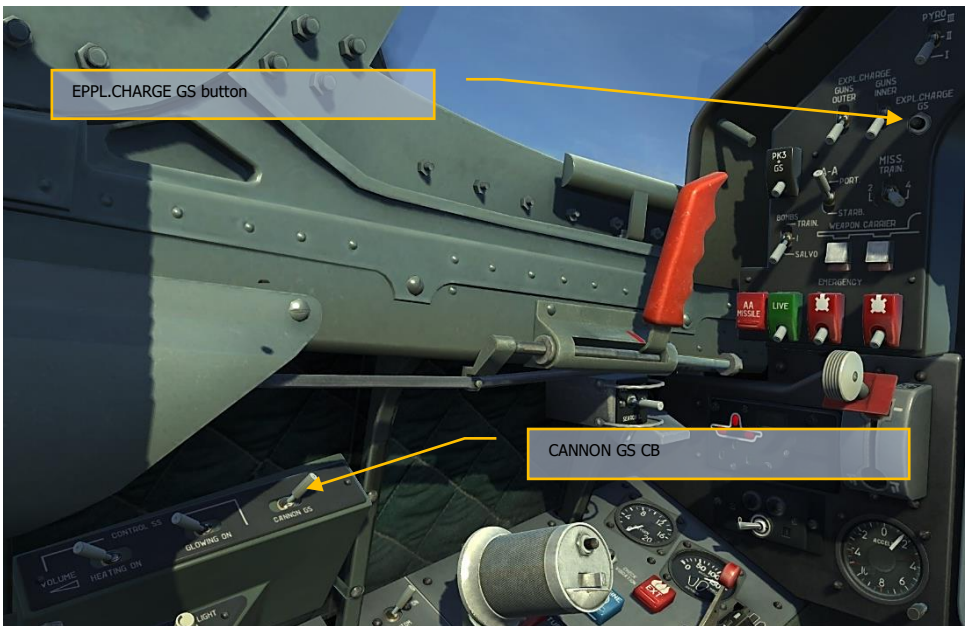

## Actions in the Target Area

1. Approach the target at the specified altitude and speed
2. Enable LAUNCH CB [LAlt+1]

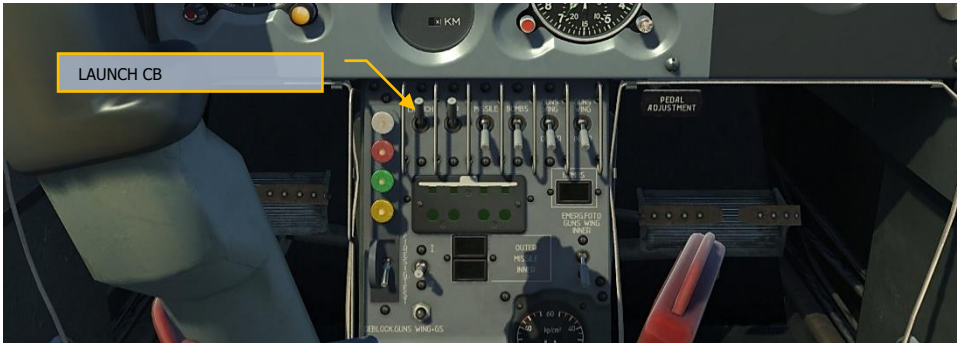

3. Set the GYRO – FIXED switch to GYRO [LShift+J]
4. Perform the target approach maneuver so that the target moves to the specified sight angle (turn start point)
5. Start the turn to the attack heading with a roll of 60- 120° and simultaneous diving at the moment of the target approach to the specified sight angle. During the diving, do not decrease the engine speed under 90%
6. Finish the turn and diving so that the sight reticle center is under the target
7. Lift the TB [LCtrl+Space] cap, enter the maximum range into the sight [;], align the sight reticle center with the target center
8. Hold the sight reticle center on the target during the dive
9. When the target fits in the circle formed by the sight reticle rhombi, press the TB [Space] and fire
10. Immediately after the firing, pull out with the g-load 3 to 3.5 and simultaneously accelerate to the takeoff power
11. After pulling out, enter the minimum range into the sight and commence the next attack maneuver





2. Enable ASP CB[LAlt+2]

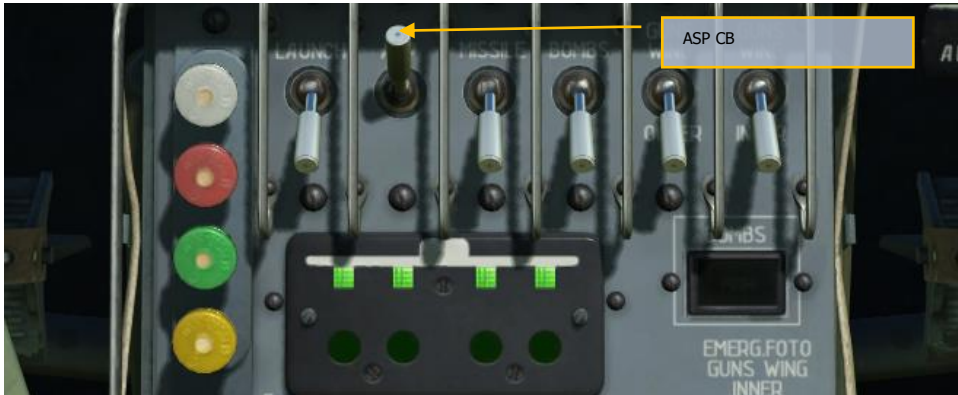

3. Set the sight reflector inclination angle
4. Set the fictitious target base
5. Set the GYRO – FIXED switch to FIXED [LShift+J]
6. Enter the maximum range into the sight [;]
7. Enable GUN WING OUTER CB [LShift+5]
8. Enable GUN WING INNER CB [LShift+6]

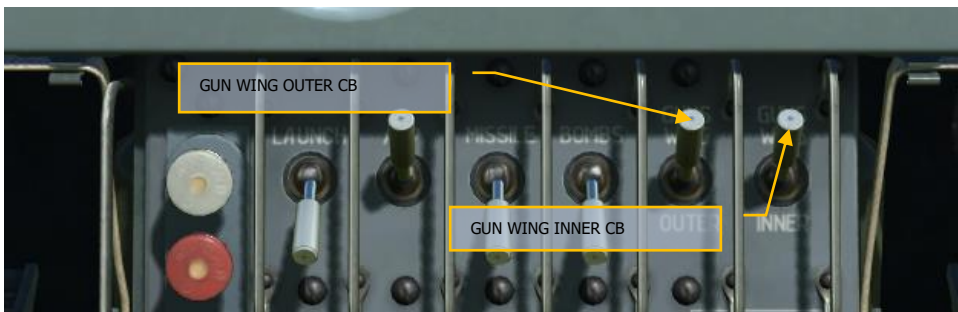

9. Switch on the EXPL.CHARGE GUNS INNER switch [LAlt+LCtrl+LShift+E]
10. Switch on the EXPL.CHARGE GUNS OUTER switch [LAlt+LCtrl+LShift+W]
11. Select the pylons via the WEAPON CARRIER buttons  
[LShift+6] — inner  
[LShift+5] — outer

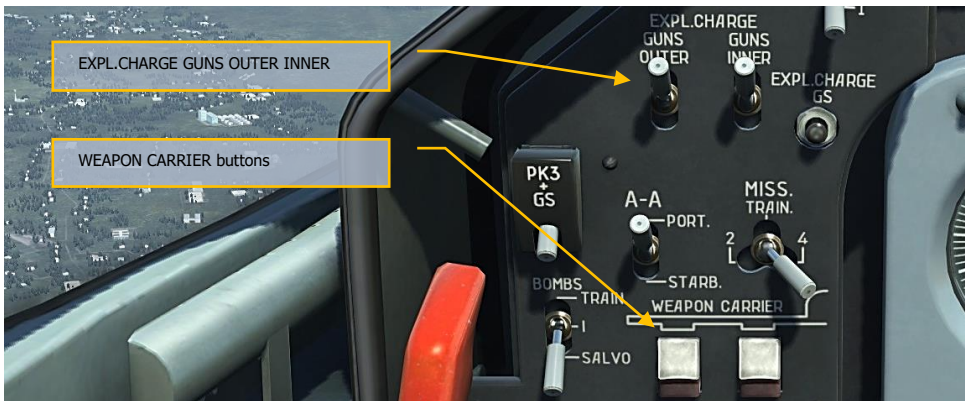

## Actions in the Target Area

1. Approach the target at the specified altitude and speed
2. Enable LAUNCH CB [LAlt+1]

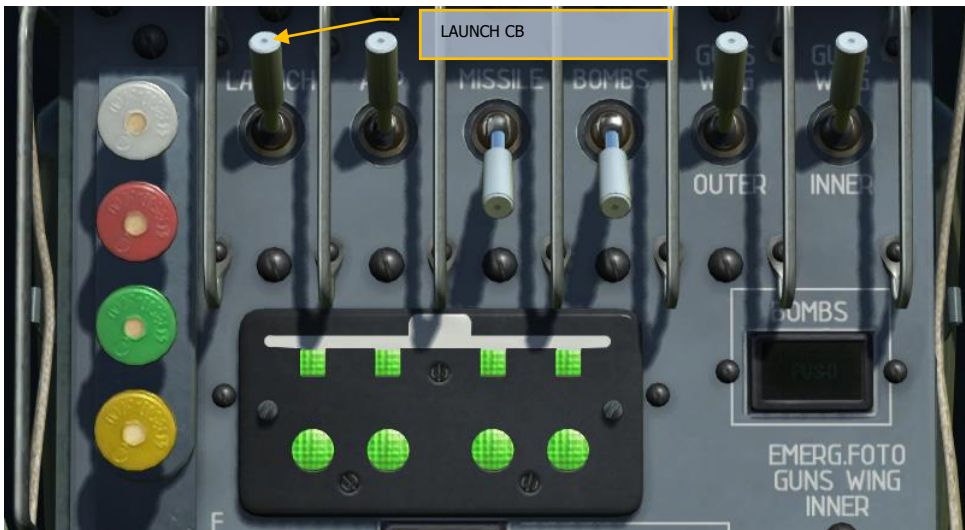

3. Perform the target approach so that the target moves to the specified sight angle (turn start point)
4. Start the turn to the attack heading with a roll of 60–120° and simultaneous diving at the moment of the target approach to the specified sight angle. During the diving, set the engine speed to 90-92%
5. Finish the turn and diving so that the sight reticle center is under the target

6. Lift the TB [LCtrl+Space] cap and align the sight reticle center with the target center
7. Hold the sight reticle center on the target during the dive
8. When the target fits in the circle formed by the sight reticle rhombi, press the TB [Space] and fire
9. Immediately after firing, pull out with the g-load 3 to 3.5 and simultaneously accelerate to the takeoff power

# EMERGENCY PROCEDURES



# EMERGENCY PROCEDURES

In the event of an emergency situation during the flight, pilot must check whether there was an error when working with cockpit's equipment. Pay special attention to checking CBs and switches, related to the particular case. If CBs and switches were not in correct positions, immediately set them in the appropriate positions, check if emergency situation is resolved and continue the flight. If emergency occurs due to failure or combat damage, one must use external symptoms and signalization. Identify the root cause of the issue and resolve it, following the appropriate procedure.

## Engine Failure

Symptoms:

- Changes in the sound of the engine operation
- Rapid drop of RPM and EGT
- Reduction of the airspeed
- ENG. MIN. OIL PRESS signal is on
- GENERATOR signal is on and the RAT is extending (extended)
- Master caution signal is on

Actions:

- Set the throttle to the «STOP» position
- Constantly monitor speed and altitude
- Turn towards the airfield
- Start the engine

## Air Start of the Engine

Reliable engine start is performed at altitudes up to 6000m.

If engine autorotation RPM is lower than 15% ( $n_1$  pointer), engine start requires air starter to be started to spin up the high pressure compressor (HPC).

If engine autorotation RPM is higher than 15% ( $n_1$  pointer), engine start does not require air starter to be started to spin up the high pressure compressor (HPC).

## Engine start with spinning up the HPC (APU assisted air start)

- Set speed of 300 – 350 km/h
- Make sure that autorotation RPM is lower than 15 %
- Press the TURBO button for 1-2 seconds
- When the TURBINE STARTER signal is on, press the ENGINE button for 1-2 seconds
- After 3-6 seconds the ENGINE was pressed, move the throttle from the STOP position to IDLE
- Engine RPM and EGT should start increasing
- After engine start RPM should be not less than 54,5%, EGT – not more than 600°C, oil pressure at engine inlet – not less than 2 kg/cm<sup>2</sup>
- When engine was started, increase RPM and make sure that engine operates correctly.

## Engine start without spinning up the HPC (Windmill air start)

- Set speed of not less than 430 km/h
- Ensure that autorotation RPM is not less than 15 %
- Press the ENGINE button for 1-2 seconds
- After 3-6 seconds the ENGINE was pressed, move the throttle from the STOP position to IDLE
- Engine RPM and EGT should start increasing
- After engine start RPM should be not less than 54,5%, EGT – not more than 600°C, oil pressure at engine inlet – not less than 2 kg/cm<sup>2</sup>
- When engine was started, increase RPM and make sure that engine operates correctly

**Note: If engine start was not successful, assess the situation, take a decision to do an emergency forced landing or eject.**

## Spontaneous Changing or Holdup of Engine RPM

In case of spontaneous changing or hanging of engine RPM (engine does not react on throttle movements), switch engine to emergency fuel system (EFS).

Actions:

- Set throttle in the IDLE position
- Enable the SEC. REG., as a result FUEL EMERG. DELIVERY signal goes on

- By slowly moving the throttle, not faster than 2% per second, set the required flight mode

When engine operates from EFS:

- Fuel regulator automatics and electrical stop valve do not operate
- Do not allow engine RPM drop of less than 56% at altitudes of up to 2000 m. and 60 % at altitudes of 2000 m
- Up to 2000 m. engine RPM should not exceed 103%, from 2000 m. and up to 8000 m. – 99%
- Changing engine operation mode from «IDLE» to «NOM» should take not less than 15 seconds

**NOTES:**

**If during enabling the SEC. REG. (Emergency fuel) the throttle is at higher mode than IDLE engine self-stop is possible.**

**If during enabling the SEC. REG. (Emergency fuel) or during operation from EFS, engine self-stop occurs, engine should be started from EFS.**

## Engine start from EFS with spinning up the HPC (APU assisted air start from EFS)

- Set speed of 300 – 350 km/h
- Make that autorotation RPM is less than 15 %
- Press the «TURBO» button for 1-2 seconds
- When the TURBINE STARTER signal is on, press the ENGINE button for 1-2 seconds
- After 10 seconds the ENGINE button was pressed, move the throttle from the STOP position to the position marked by the triangle
- When EGT starts increasing, by moving the throttle regulate engine fuel supply, so that engine RPM is not less than 56% up to 2000m and not less than 60% at altitudes higher than 2000m
- When HPC RPM is 41,5 – 44,5% disable the Sapphire-5 by TURBO STOP switch
- when engine is started, EGT should be not more than 600°C, oil pressure at engine inlet – not less than 2 kg/cm<sup>2</sup>
- After engine was started, increase RPM and make sure that engine operates correctly

## Engine start from ESF without spinning up the HPC (Windmill air start from EFS)

- Set speed of not less than 450 km/h
- Ensure that autorotation RPM is not less than 15 %



- Press the ENGINE button for 1-2 seconds
- After 3-6 seconds the ENGINE button was pressed, move the throttle from the STOP position to the position marked by the triangle
- When EGT starts increasing, by moving the throttle regulate engine fuel supply, so that engine RPM is not less than 56% up to 2000m and not less than 60% at altitudes higher than 2000m
- When engine is started, EGT should be not more than 600°C, oil pressure at engine inlet – not less than 2 kg/cm<sup>2</sup>
- After engine was started, increase RPM and make sure that engine operates correctly

## Engine Fire

Symptoms:

- FIRE signal is on
- Master caution signal is on
- J.P.T. 700°C and J.P.T. 730°C signals are on
- Smoke tail behind the airplane (can be detected during turn)

Action:

- Set the throttle to the STOP position
- Close the shut-off fuel valve
- Press the EXT button
- After fire was extinguished, assess the situation, take a decision to do an emergency forced landing or eject

## Engine Surge

Symptoms:

- Periodic bangs in the engine compartment
- RPM and fuel pressure oscillations
- Increase of EGT, J.P.T. 700°C and J.P.T. 730°C signals go on
- Possibly, self-stop of the engine

Actions:

- Move the throttle to a lower RPM operation mode, until engine surge symptoms disappear

## Landing Gear Failure (Emergency Gear Extension)

### Symptoms:

- Some (one or two) of three green lamps, indicating successful gear extraction, is/are off
- Mechanical gear pointers are not extended completely

### Actions:

- Set speed of horizontal flight within 300 – 320 km/h
- Deflect emergency landing gear extension handle on the right panel in front or rear cockpit back
- Make sure that gear is extended by checking that all three green lamps, indicating successful gear extension, illuminate, and mechanical indicators are all the way up

If the emergency gear release failed, set the gear extension handle in retracted position, emergency gear extension handle set all the way forward. Jettison stores and perform belly landing (with retracted gear) on unpaved runway.

- At altitude of not less than 100 m. set the throttle to the STOP position, close fuel shut-off valve, disable the BATTERY, (NETW in the rear cockpit) and GENERATOR EMERG

## ADI Failure

### Symptoms:

- ADI readings do not correspond to flight mode
- "АРЕТИР" (Cage) lamp-button is on

### Actions:

- Set speed of 350 km/h
- If flying in simple weather conditions, control the airplane, using natural horizon as a reference
- If flying in adverse weather conditions, control the airplane, using T/S indicator for roll assessment. Pitch is estimated based on vertical velocity
- Approach the airfield and land
-

## GMK-1AE Failure

Symptoms:

- GMK-1AE readings do not correspond to actual heading
- Heading scale is fixed or oscillates from side to side

Actions:

- Approach the airfield using RKL-41 and KI-13
- Landing approach in adverse meteorological conditions is performed with help of RKL-41, KI-13

## Flaps Non-Extension

Symptoms:

- Signal lamp, indicating that flaps are extended, is off
- Flaps extension button does not return to initial position

Actions:

- Check speed, it should not exceed 310 km/h (at speed of 310 km/h flaps extension is blocked)
- Set horizontal flight speed of 280 km/h
- Deflect emergency flaps extension handle on the right panel in front or rear cockpit back

If, due to some reasons, flaps extension is failed (main and emergency systems failures, combat damages), land with retracted flaps. Glideslope speed should be within 250-270 km/h. Glide path should be shallow.

## Oil Pressure Drop at Engine

Symptoms:

- ENG. MIN. OIL PRESS signal is on
- Oil pressure is less than 3 kg/cm<sup>2</sup> at RPM of 95% and above
- Oil pressure is less than 2 kg/cm<sup>2</sup> at other modes

Actions:

Set speed of 300 km/h and land airplane as soon as possible

In case of engine self-stop do the forced landing or eject

## Pitot System Failure

Symptoms:

- VD-20, KUSM-1200, VAR-80, UVPD readings do not corresponds to actual flight mode (for example: airplane is climbing but gauges show descent and vice versa, decrease or increase of speed in steady flight)

Actions:

- Set the PITOT TUBE MAIN STBU in the STBY position
- If the gauges readings were restored, continue the flight

In case of primary and backup system failure is necessary to:

- Perform horizontal flight using ADI, pitch angle should be  $+2^\circ$ , engine RPM is within 92-96% at altitudes of 1000-5000m. and 95 – 99% at altitudes of 5000 – 10 000 m. This modes corresponds to speed of 400 km/h
- Descend with pitch angle of  $-2^\circ$  (ADI) at idle RPM
- Estimate current altitude, using the fact, that in this mode descend of 1000m takes approximately 2.5 min
- Use RV-5M from altitude of 750m
- Fly circle-pattern with retracted gears and pitch angle of  $+2^\circ$  (ADI) and RPM of 90%, which corresponds to speed of 350 km/h
- Fly with extended gear and flaps extended at  $25^\circ$  after 3<sup>rd</sup> turn at RPM of 85%, pitch angle of  $-2^\circ$ , which corresponds to speed of 280 km/h
- Extend flaps at  $44^\circ$  over the outer NDB, set RPM of 90% and pitch angle of  $-4^\circ$
- Monitor altitude over outer and inner NDBs using RV-5M

**NOTE: UVPD can be used by the pilot for altitude estimation in case of VD-20 altimeter failure. Up to 2000m. UVPD readings are equal to altitude readings, above 2000m altitude can be estimated using the following equation**

Altitude equation:  $HUVPD = HVD - 2000 / 2 + 2000$ .

VD-20 altitude	UVPD altitude
2500 m.	2250 m.
3000 m.	2500 m.
3500 m.	2750 m.
4000 m.	3000 m.
4500 m.	3250 m.
5000 m.	3500 m.

## Bingo Fuel

Symptoms:

- 150 KG FUEL signal is on
- Master caution signal is on

Actions:

- Assess possibility of landing at the nearest airfield, taking into account that 150 kg of remaining fuel is enough for 17 min. flight at altitude of 1000m and speed of 400 km/h.

## Main Generator Failure

Symptoms:

- GENERATOR signal is on, EMERGENCY GENERATOR signal can be on within some amount of time (while RAT is extending)
- Distinctive sound of RAT extension (EMERGENCY GENERATOR signal goes off)
- RSBN-5S disables automatically, if needed, RSBN-5S equipment can be enabled using the EMERG. CONNECTION RSBN CB.

Actions:

- Make sure that generator operates correctly and voltage is within 27-29 V
- Approach airfield and land

**NOTE: If RAT was not extended, it must be extended manually. Set the RAT extension valve in back position on the right panel in front or rear cockpit. After landing and lowering the front strut, RAT will be retracted automatically.**

## Primary and Backup Generators Failure

Symptoms:

- GENERATOR and EMERGENCY GENERATOR signals are on
- Voltage is within 23-24 V
- RSBN-5S and SRO were disabled automatically

Actions:

- Disable the 115V INVERTOR I, 115V INVERTOR I and MRP-RV CBs
- land as soon as possible

**NOTE: If consumers were disabled in time, battery can provide power supply for remaining equipment for 15 min. during the day and 10 min. during the night. If needed, the «EMERG. CONNECTION RSBN» and «EMERG. CONNECTION IFF» CBs can be enabled for short period. If voltage dropped to 20-21 V. extend gear and flaps manually.**

## Canopy Destruction

- Decrease speed to 270 km/h
- Descend to altitude of less than 4000 m
- Land

## Smoke in Cockpit – Cockpit Depressurization

- Switch to pure oxygen supply, for that set the «100% O<sub>2</sub> – NORMAL» valve to 100% O<sub>2</sub> position
- Descend to altitude of less than 4000 m

- Unseal the cockpit
- Land

## Forced landing

To do a forced landing pilot must in the first place estimate the possible gliding range, taking into account altitude and distance to the landing airfield.

<i>Airplane configuration</i>	<i>V km/h</i>	<i>Lift/Drag ratio</i>	<i>Vertical speed m/s</i>
<i>Gear - retracted, flaps- 0°</i>	300	10	10
<i>Gear - extended, flaps- 0°</i>	300	7	11
<i>Gear - extended, flaps- 25°</i>	280	5,5	13
<i>Gear - extended, flaps- 44°</i>	260	3,6	15-17

One must take into account that while gliding in flight configuration at speed of 300 km/h, altitude loss (in absence of the wind) is equal to 100 m. per 1 km. Altitude loss due to 180° turn with 30° roll is 450 m, with 45° roll is 350 m.

During assessment altitude over the control point must be taken into account. Control point on an airfield is outer NDB. Use the following equation for assessment:

$$L_{\text{glide}} = (H_{\text{flight}} - H_{\text{outerNDB}}) * \text{Lift/ Drag Ratio}$$

**Example: Airplane is 15 km away, at altitude of 3000m**

$$L_{\text{glide}} = (3-1) * 10 = 20 \text{ km}$$

**Based on this calculation pilot is sure that landing is possible**

If outer NDB is approached at angle of 90° or at opposite to landing course (downwind leg), one must take into account altitude loss while turning towards landing course. In this case altitude loss due to turn should be added to the altitude over control point.

## Flameout Landing

- Jettison all stores
- Set gliding IAS of 300 km/h
- Turn towards the airfield
- Constantly assess opportunity of flying over outer NDB at altitude of not less than 600 m and not more than 1000 m
- If estimated altitude over outer NDB is from 1100 to 1500m, perform zigzag (snake) maneuver. At zigzag angles of 15, 30 and 45° additional altitude loss is 20, 50 and 100 m. and airplane flies the distance of 1,2 and 3 km correspondingly
- When flying over outer NDB at altitudes of 1500-1800 m, turn with 30° roll
- When approached outer NDB at altitudes of 1900m and above, turn at 180°, and then back to landing course

Altitude for performing turn back to landing course can be estimated using the following equation:

$$H = H_{\text{outerNDB}} / 2 + 500\text{m.}$$

**Example: Outer NDB was passed at altitude of 1900m.**

**Estimate altitude at which turn to landing course should be performed:**

$$H = 1900 / 2 + 500 = 1450\text{m.}$$

- When estimated altitude is reached turn at landing course
- Before outer NDB extend landing gear and set speed of 280 km/h
- based on altitude over outer NDB take a decision to release flaps (if altitude over outer NDB is 600m landing is performed with retracted flaps or with flaps in takeoff position)
- After passing outer NDB extend flaps at 25° and maintain speed of 280 km/h
- Having full confidence that assessment was correct and landing on runway is still possible, extend flaps at 44°, set speed of 260 km/h
- Descent point for estimated glideslope is located at distance of 100-200m from the beginning of the runway
- Flaring must be performed based on vertical descent speed, in case of vertical speed of 10-15 m/s, perform two-stage flaring. At altitude of 50 m do the first flaring. While flaring move descent point to beginning of the runway, vertical speed is reducing to 3-5 m/s. Second flaring is performed in a normal way at altitude of 8-10 m. If altitude over outer NDB is 600 m, flaring is performed in a standard way.



## Flameout Belly Landing

If landing cannot be performed on the airfield, pilot has to take decision on forced landing on some area, which looks suitable. Belly landing at unknown surface is performed with jettisoned stores, retracted gears and extended flaps.

When suitable surface is found, set speed of 300 km/h, do the initial approach, estimation and landing.

- Having full confidence that estimation was correct and landing on chosen area is still possible, extend flaps first at 25° and then at 44°, set gliding speed of 250-260 km/h
- Make sure that the throttle is in «STOP» position
- At altitude of not less than 100m, close the fuel shut-off valve, disable the **BATTERY (NETW in rear cockpit), GENERATOR EMERG.**
- Flaring must be performed based on vertical descent speed, in case of vertical speed of 10-15 m/s, perform two-stage flaring. At altitude of 50 m do the first flaring. While flaring move descend point to beginning of the runway, vertical speed is reducing to 3-5 m/s. Second flaring is performed in a normal way at altitude of 8-10 m. If altitude over outer NDB is 600 m, flaring is performed in a standard way

If during descent:

- Speed is constant, then the assessment is correct
- Speed is increasing, then landing at runway (surface) is possible, but altitude is higher than needed and it must be reduced to a value allowing gliding with a constant speed (perform sliding or consequent turns from side to side)
- Speed is decreasing, then the airplane will not reach the runway (surface)

# FLIGHT CHARACTERISTICS



## FLIGHT CHARACTERISTICS L-39

Main specifications			
<b>1. Maximum allowed true air speeds in horizontal flight (flight weight is 4000 kg):</b>			
<b>a) engine operating at maximum thrust (<math>n_{1hpc} = 106,8 \pm 1\%</math>)</b>			
at ground level	km/h	702*	
at 5000 m	km/h	757*	
at 6000 m	km/h	760*	
at 10000m	km/h	737	
<b>b) engine operating at nominal thrust (<math>n_{1hpc} = 103,2 \pm 1\%</math>)</b>			
at ground level	km/h	640*	
at 5000 m	km/h	712*	
at 6000 m	km/h	720*	
at 10000m	km/h	694*	
<b>2. Maximum vertical speeds (take off weight is 4300 kg):</b>			
<b>a) engine operating at maximum thrust (<math>n_{1hpc} = 106,8 \pm 1\%</math>)</b>			
at ground level	m/s	22	
at 6000 m	m/s	10,8	
at 10000m	m/s	3,4	
<b>b) engine operating at nominal thrust (<math>n_{1hpc} = 103,2 \pm 1\%</math>)</b>			
at ground level	m/s	16,3	
at 6000 m	m/s	8	
at 10000m	m/s	2,6	
<b>3. Service ceiling (standard conditions, take off weight 4300 kg)</b>			
	m	11 500	
<b>4. Minimum time required for reaching altitudes (standard conditions, take off weight 4300 kg)</b>			
<b>a) engine operating at maximum thrust (<math>n_{1hpc} = 106,8 \pm 1\%</math>)</b>			
6000 m	min	6,4	
10000 m	min	16,9	
service ceiling, when from 10000m engine operates at nominal thrust	min	40	
<b>b) engine operating at nominal thrust (<math>n_{1hpc} = 103,2 \pm 1\%</math>)</b>			
6000 m	min	8,6	
10000 m	min	22,4	
service ceiling	min	40,8	
<b>5. Maximum range and duration of flight, when flying at 5000 m with 5% remaining fuel</b>			
- with empty wing tanks is 850 km and 2 h 11 min			
- with full wing tanks 1015 km and 2 h 35 min.			
<b>6. Take off roll on paved runway with engine operating at maximum thrust needed to reach take off speed of 185-190 km/h is 480-530 m.</b>			
<b>7. Landing roll on paved runway with use of gear brakes when landing with IAS of 180 km/h is 650-690 m.</b>			

\*: speeds listed here are in compliance with standard conditions (ISA).

## Typical Speeds of Level Flight

- Minimum (stall speed)
- Cruise
- Maximum

Minimum speed (stall speed) is a speed at which lift force is maximum (Lift factor = 1.31). In flight configuration with weight of 4100 kg this speed is equal to 180 km/h, in takeoff configuration -165 km/h, and in landing configuration – 145 km/h. Due to safety reasons flight is allowed at speed which is slightly higher than minimum speed. This is so called evolution speed, equal to 200 km/h.

Cruise speed is a speed at which aerodynamic drag is minimal. Horizontal flight at cruise speed is performed at optimal AoA  $\alpha_{opt} - 7^\circ$  when aerodynamic quality (lift-to-drag ration) is the highest. In flight configuration with weight of 4100 kg this speed is equal to 300 km/h at  $\alpha_{opt} - 7^\circ$ .

Maximum speed of horizontal flight is reached when engine is producing maximum thrust.

Maximum allowed speed is a speed which never should be exceeded due to airplane's structural limits, stability and controllability.

In flight configuration with weight of 4100 kg this speed at ground level is equal to 900 km/h.

Due to stability and controllability reasons (in order to avoid being dragged into a dive) maximum speed is limited by Mach number.

In flight configuration with weight of 4100 kg in standard conditions  $M_{allowed} = 0.8$ , which corresponds to speed at ground level of 900 km/h.

Up to altitude of 1300 m maximum speed is mostly limited by airplane's structural limit, pilot must control IAS.

At altitudes higher than 1300 m maximum speed is limited by stability and controllability, pilot must control Mach number.

With the increase of the altitude maximum allowed speed decreases.

L-39 in the horizontal flight cannot exceed speed limitation, but it can be done during descent. Therefore, when  $Mach=0,78 \pm 0,02$  is reached, the air brakes extends automatically. They create moment which forces airplane to exit from a dive.

During acceleration airplane is stable and has no roll tendency. When speed is increases airplane tries to exit from a dive.

## Service Ceiling

The service ceiling is the maximum usable altitude of an aircraft.

For the L-39 service ceiling is an altitude at which vertical speed is equal to 0.5 m/s, which is 11500m.

Routine for reaching service ceiling:

After takeoff maintain IAS of 400 km/h up to altitude at which TAS reaches 500 km/h, maintain this speed (TAS=500 km/h) constant until service ceiling is reached.

## Airplane Controllability

Stick movement needed for changing G-factor depends on speed: the higher the speed the more sensitive the airplane.

When the speed increases from 300 to 600 km/h stick movement required to create the same G-factor reduces by 4 times.

Ailerons are efficient up to stall speeds.

Maximum roll rate when ailerons completely deflected at speed of 380 km/h is 140°/s.

Rudder control reversal is absent within the full speed range.

Maximum slide angle reached when pedal is fully deflected is equal to 10°.

When pedal is fully deflected required balancing roll at speed of 230 km/h is approximately 10°, at 280 km/h – 15°.

## Pitch Balance in Level Flight

In flight configuration with weight of 4100 kg, with elevator trimmer in 0° and neutral stick airplane is balanced at speed of 380 km/h. Small pushing forces are applied on the stick.

When speed is higher than 380 km/h to balance the airplane the stick needs to be deflected forward, pushing force increases.

When speed is lower than 380 km/h to balance the airplane stick needs to be pushed slightly forward and with further speed decrease pulled towards the pilot.

To remove static forces from the stick trimmer must be used. In flight configuration airplane can be balanced with help of trimmer within full speed range of steady horizontal flight.

Change in balance depending on configuration:

- During gear extension and flaps extension to 25° dive moment occurs, which should be compensated by pulling the stick
- During flaps extension to 44° dive moment occurs, which normally should be compensated by pulling the stick, but simultaneously with extension servo compensator triggers and fully compensates this dive moment (pulling forces on the stick), therefore pilot must deflect the stick forward
- During air brakes extension climb moment occurs, which should be compensated by pushing the stick forward

When engine RPM increases from IDLE to TAKE OFF, climb moment appears, therefore stick needs to be pushed forward slightly.

# SUPPLEMENTS



## SUPPLEMENTS

## Airdrome Data of Caucasus Map

Airdrome	Runway	TACAN, channel	ILS	RSBN channels		Outer NDB, kHz	Inner NDB, kHz	Tower comm frequencies, MHz
				N	P			
UG23 Gudauta - Bambora (Abkhazia)	15-33, 2500m						395 (33)	209.00/130.0/40.2 0/4.20
UG24 Tbilisi - Soganlug (Georgia)	14-32, 2400m							218.0/139.0/42.0/ 4.65
UG27 Vaziani (Georgia)	14-32, 2500m	22X (VAS)	108.75					219.0/140.0/42.20 /4.70
UG5X Kobuleti (Georgia)	07-25, 2400m	67X (KBL)	07 ILS - 111.5			870	490	212.0/133.0/40.80 /4.35
UGKO Kutaisi - Kopitnari (Georgia)	08-26, 2500m	44X (KTS)	08 ILS - 109.75				477 (08)	213.0/134.0/41.0/ 4.40
UGKS Senaki - Kolkhi (Georgia)	09-27, 2400m	31X (TSK)	09 ILS - 108.9			335	688	211.0/132.0/40.60 /4.30
UGSB Batumi (Georgia)	13-31, 2400m	16X (BTM)	13 ILS - 110.3				430 (31)	210.0/131.0/40.40 /4.25
UGSS Sukhumi - Babushara (Abkhazia)	12-30, 2500m					489	995	208.0/129.0/40.0/ 4.15
UGTB Tbilisi - Lochini (Georgia)	13-31, 3000m		13 ILS - 110.3 31 ILS - 108.9			342 (13)  211 (31)	923 (13)  435 (31)	217.0/138.0/41.80 /4.60
URKA Anapa - Vityazevo (Russia)	04-22, 2900m					443	215	200.0/121.0/38.40 /3.75
URKG Gelendzhik (Russia)	04-22, 1800m						1000	205.0/126.0/39.40 /4.00
URKH Maykop - Khanskaya (Russia)	04-22, 3200m			34	36 (04)	288	591	254.0/125.0/39.20 /3.95
URKI Krasnodar - Center (Russia)	09-27, 2500m			40	38 (09)	625	303	251.0/122.0/38.60 /3.80
URKK Krasnodar - Pashkovsky (Russia)	05-23, 3100m					493	240	207.0/128.0/39.80 /4.10



URKN Novorossiysk (Russia)	04-22, 1780m							202.0/123.0/38.80 /3.85
URKW Krymsk (Russia)	04-22, 2600m			28	26	408	803	253.0/124.0/39.0 /3.90
URMM Mineralnye Vody (Russia)	12-30, 3900m		12 ILS - 111.7 30 ILS - 109.3			583	283	214.0/135.0/41.20 /4.45
URMN Nalchik (Russia)	06-24, 2300m		24 ILS - 110.5			718 (24)	350 (24)	215.0/136.0/41.40 /4.50
URMO Beslan (Russia)	10-28, 3000m		10 ILS - 110.5			1050 (10)	250 (10)	220.0/141.0/42.40 /4.75
URSS Sochi - Adler (Russia)	06-24, 3100m		06 ILS - 111.1				761 (06)	206.0/127.0/39.60 /4.05
XRMF Mozdok (Russia)	08-27, 3100m			20	22	525	1065	266.0/137.0/41.60 /4.55

## Airdrome Data of NTTR Map

Airdrome	Runway	TACAN, channel	ILS	Tower comm frequencies, MHz
KXTA Groom Lake AFB (USA)	14L-32R 3500m	18X (GRL)	32 ILS - 109.30 (GLRI)	252.0/123.0/38.8
KINS Creech AFB (USA)	13-31 1500m, 08-27 2700m	87X (INS)	13 ILS - 108.5 (ICRS)	251.0/122.0/38.6
KLSV Nellis AFB (USA)	03L-21R 3000m, 03R-21L 3000m	12X (LSV)		254.0/125.0/39.2
KLAS McCarran International (USA)	07R-25L 3100m, 07L-25R 3300m, 01R-19L 2500m, 01L-19R 2500m	116X (LAS)	25 ILS - 111.75 (IRLE)	253.0/124.0/39.0

## Sources

1. Самолёт Л-39 Руководство по лётной эксплуатации. Москва, Военное издательство, 1988.
2. Самолёт Л-39 Часть 1 Самолёт и двигатель. Москва, Военное издательство, 1980.
3. Самолёт Л-39 Часть 2 Авиационное и радиоэлектронное оборудование. Москва, Военное издательство, 1990.
4. Самолёт Л-39 Часть 3 Вооружение и его боевое применение. Москва, Военное издательство, 1988.
5. Практическая аэродинамика учебных реактивных самолётов Часть 2 Практическая аэродинамика самолёта Л-39. Под. ред. Н.М. Лысенко. Москва, Военное издательство, 1985.
6. Техническая документация самолёта Л-39. Книга 1, Лётные характеристики, 1974.
7. Техническая документация самолёта Л-39. Книга 14, Инструкция лётчику, 1976.

- <http://www.l-39.cz>
- <http://www.airliners.net>
- <http://www.airwar.ru>
- <http://theworldofmark.com>
- <http://aerobaticteams.net>
- <http://letaem-vmeste.livejournal.com>
- <http://airspotter.eu>
- <http://www.razlib.ru>

# Eagle Dynamics

## Management

Nick Grey	Project Director, Director of The Fighter Collection
Igor Tishin	Project Development Manager, Director of Eagle Dynamics, Russia
Andrey Chizh	Assistant Development, Producer, technical documentation, game design
Matt "Wags" Wagner	Producer, game and technical documentation, game design
Matthias "Groove" Techmanski	European Manager
Alexander Pidchenko	Project Manager

## Programmers

Alexander Oikin	Lead programmer
Dmitry Baikov	System, multiplayer, sound engine
Ilya Belov	GUI, map, input
Maxim Zelensky	AC, AI AC, flight dynamics, damage model
Andrey Kovalenko	AI AC, avionics
Evgeny Pod'yachev	Plugins, build system
Timur Ivanov	Effects, graphics
Oleg "Olgerd" Tischenko	Avionics
Konstantin Tarakanov	GUI, mission editor
Eugeny Panov	AI
Michael Ershov	AI
Alexey Saenko	Graphics
Alexey Militov	Effects

Grigory Manukyan	Graphics
Roman "Made Dragon" Deniskin	Aircraft systems, flight dynamics
Alexander Mishkovich	AC systems, avionics, failures, damages, incockpit helper

## Artists

Pavel "DGambo" Sidorov	Lead artist
Alexander "Skylark" Drannikov	GUI graphic, AC models
Timur Tsigankov	AC, vehicles, ships, weapons models
Eugeny "GK" Khizhnyak	AC, vehicles
Maxim Lysov	AC models

## Sound

Konstantin "btd" Kuznetsov	Sound Engineer, Music Composer
----------------------------	--------------------------------

## Quality Assurance

Valery "USSR_Rik" Khomenok	Lead Tester
Ivan "Frogfoot" Makarov	Testing
Alexander "BillyCrusher" Bilievsky	Testing
Nikita "Nim" Opreddenkov	Testing
Oleg "Dzen" Fedorenko	Testing

## Science Support

Dmitry "Yo-Yo" Moskalenko

Mathematical models of dynamics, systems, ballistics

## IT and Customer Support

Konstantin "Const" Borovik

System and network administrator, WEB, forum

Andrey Filin

System and network administrator, Customer Support

Konstantin "MotorEAST" Kharin

Customer support

## Localization

Alexey "Mode" Chistyakov

Localization Manager

Vitaliy "Zulu" Marchuk

English translation

Julia "Umka" Marchuk

English translation

## Testers Staff

Anthony "Blaze" Echavarria

Christopher "Mustang" Wood

Daniel "EtherealN" Agorander

Danny "Stuka" Vanvelthoven

Darrell "AlphaOneSix" Swoap

Dmitry "Laivynas" Koshelev

Dmity "Simfreak" Stupnikov

Edin "Kuky" Kulelija

Erich "ViperVJG73" Schwarz  
Evan "Headspace" Hanau  
Gareth "Maverick" Moore  
Gavin "159th\_Viper" Torr  
George "GGTharos" Lianeris  
Grayson "graywo1fg" Frohberg  
Jeff "Grimes" Szorc  
John "Speed" Tatarchuk  
Jurgen "lion737" Dorn  
Kairat "Kairat" Jaksbaev  
Matt "mdosio" Dosio  
Matthias "Groove" Techmanski  
Norm "SiThSpAwN" Loewen  
Peter "Weta43" McAllister  
Phil "Druid\_" Phillips  
Philippe "Phil06" Affergan  
Raul "Furia" Ortiz de Urbina  
Roberto "Vibora" Seoane Penas  
Scott "BIGNEWY" Newnham  
Serge "eekz" Goretsky  
Stephen "Nate--IRL--" Barrett  
Steve "joyride" Tuttle  
Vadim "Wadim" Ishchuk  
Valery "=FV=BlackDragon" Manasyan  
Victor "vic702" Kravchuk  
Werner "derelor" Siedenburg

William "SkateZilla" Belmont

Zachary "Luckybob9" Sesar

## Special Thanks

Oleg K – Subject Matter Expert

Rudolf Andoga - Subject Matter Expert

Andrey "d3m0" Mogila – for help with manuals

Shelby Stricklen – for L-39 photos

Макс Скрябин – for L-39 photos

Ястреб – for L-39 photos

Andriy Pilschikov – for L-39 photos